

5

DESTORNILLADORES
SCREWDRIVERS
TOURNEVIS
SCHRAUBENZIEHER
CACCIAVITI
CHAVES DE FENDA
OTBEPKИ





Medalla
Salón Internacional
de la Invención
París 2007

Medal
International Inventors
Competition
Paris 2007

Medaille
Salon International
de l'Invention
Paris 2007

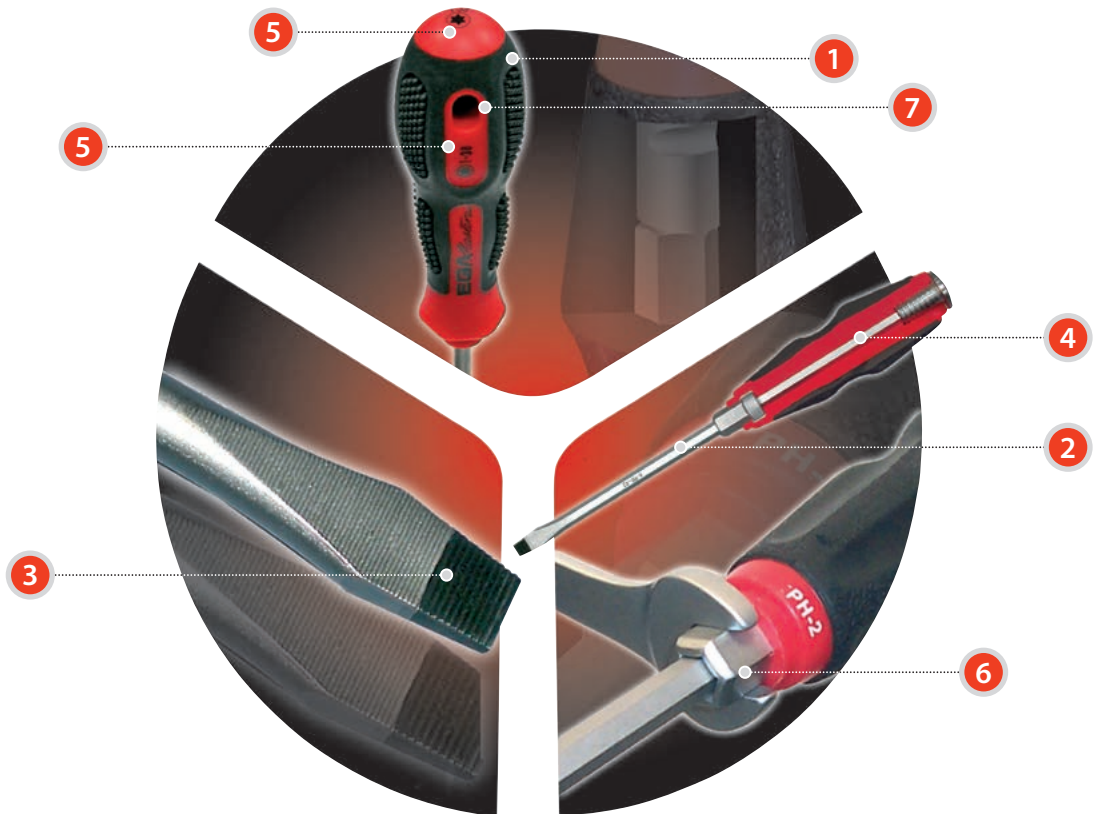

1
Equipados con mangos ergonómicos y antideslizantes más amplios, ofrecen un agarre superior evitando deslizamientos.
Oversized ergonomic & anti-slippery handles offer optimal grip for avoiding slippage.
Pourvus de manches ergonomiques et anti-dérapants plus volumineux.

2
Su varilla exclusiva de aleación cromo-molibdeno-vanadio permite aprietes un 30 % superiores a los destornilladores estándar.
Its exclusive chrome-molybdenum-vanadium alloy enables 30% higher tightening torque than traditional screwdrivers.
Sa lame "exclusivité" en alliage chrome molybdène vanadium, permet un serrage supérieur de 30% par rapport aux modèles standards.

3
Su innovador sistema de punta antideslizante y magnética facilita el posicionamiento y evita deslizamientos imprevistos.
The innovative "non-slip" anti-slippery and magnetic tip system allows an easier and safer positioning of the screwdriver, avoiding undesired slides.
Son système innovateur de tête anti-dérapante et magnétique, facilite le positionnement et fait éviter les dérapages.

4
Varilla pasante para el modelo Masterpunch, permite el golpeo en su parte superior.
Go-through bar enables hammering on the Masterpunch screwdriver's upper side.
Tige traversante pour le modèle Masterpunch, qui permet de frapper sur la partie supérieure.

5
El marcaje doble vertical y frontal de tipo y tamaño facilita la identificación rápida del destornillador que necesitamos emplear.
Type and size double marking of easy and efficient identification of the screwdriver to be used.

Le double marquage de type et de dimension facilite l'identification de l'outil recherché.

6
Modelos equipados con varilla hexagonal para aprietes con llaves.
Hexagonal bar screwdrivers available for strong tightening with wrenches.

Modèles pourvus de lames hexagonales pour le serrage avec une clé.

7
El agujero del mango permite apalancar.
Go-through hole in the handle enables tommy bar using.
Le trou sur le manche permet de serrer à l'aide d'une barre.

8
Patentado.
Patented.
Breveté.

EGA

■ **MASTERTORK**



Sistema de punta antideslizante **NON-SLIP** y magnética / *NON-SLIP antislippery magnetic tip* / **NON-SLIP** pointe brunie antidérapante et magnétique / *NON-SLIP Anti-Rutsch-Spitze*
 Punta anticívulo **NON-SLIP** / *Sistema de punta antideslizante de chave NON-SLIP* / Нескользкий магнитный наконечник

UTIL DE COMPROBACIÓN DE PAR DE DESTORNILLADORES RANURADOS / SLOTTED SCREWDRIVER TORQUE POWER TESTING TOOL / OUTIL DE VÉRIFICATION DE COUPLE DE TOURNEVIS AVEC RAINURE / SCHLITZSCHRAUBENDREHER DREHMOMENT LEISTUNGSTESTER / TEST CACCIAVITI / COMPROVADOR DE PAR PARA CHAVES DE FENDA / ТЕСТЕР КРУТЯЩЕГО МОМЕНТА ДЛЯ ПЛОСКИХ ОТВЕРТОК

COD.	L (mm)
64766	140



■ **MECÁNICO / SLOTTED / MECANICIEN / FÜR SCHLITZSCHRAUBEN / PER MECCANICI / MECÁNICO / ПЛОСКАЯ**

■ **MM**

COD.	A (mm)	B (mm)	Ø 1 (mm)	Ø 2 (mm)	L (mm)	L1 (mm)	L2 (mm)			
66400	3	0,5	3		165	80				
66401	4	0,8	4	26	185	100	85	16		●
66402					205					
66403	5,5	1	5	34	230	125	105	8		
66404					240					●
66405	6,5		6	36	265	150				
66406		1,2			280					
66407	8		7							-
66448	9,5				330	200		6		
66408	10	1,6	8	40			130			
66409	12	2								
66449	13		10		380	250				-
66410	14	2,5								

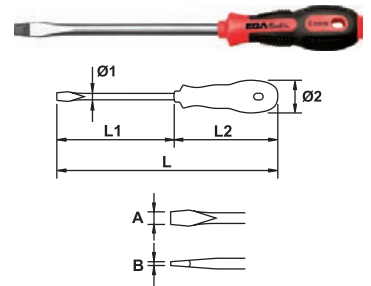

DIN 5265 | Modelo registrado / Registered model / Modèle enregistré

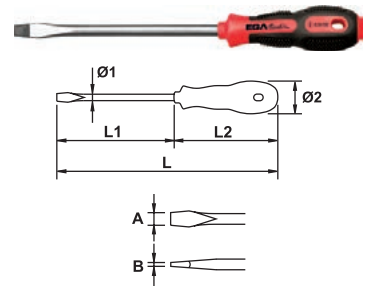

■ **INCH**

COD.	A (inch)	B (inch)	Ø 1 (mm)	Ø 2 (mm)	L (mm)	L1 (inch)	L2 (mm)			
55330	1/8	0,02	3		165	3				
55331	5/32	0,032	4	26	185	4	85	16		
55328	3/16				205					
55332	7/32	0,04	5	34	230	5	105	8		
55333					240					●
55334	1/4		6	36	265	6	115			
55335		0,046			280					
55336	5/16		7							
55337					330	8		6		
55338	3/8	0,063	8	40			130			
55339	25/64				380	10				
55329	7/16	0,08	10							-
55340	15/32									
55341	1/2	0,098								



DIN 5265 | Modelo registrado / Registered model / Modèle enregistré

EGA
MM



COD.	A (mm)	B (mm)	HEX 1 (mm)	HEX 2 (mm)	Ø 1 (mm)	L (mm)	L1 (mm)	L2 (mm)		
66413	4	0,8	4	-	26	185	100	85	16	
66414	5,5	1	5	-	34	230	125	105	8	
66415	6,5	1,2	6	-	36	240	150	115		•
66416	8	1,6	8	11	40	330	200	130	6	
66417	10	2	10	16	40	380	250			-
66418	12	2,5	12	16	40	380	250			-
66419	14	2,5	14	16	40	380	250			-

DIN 5265 | Modelo registrado / Registered model / Modèle enregistré

CARACTERÍSTICAS / FEATURES / CARACTÉRISTIQUES

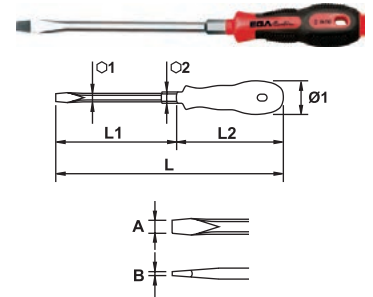
Hexagonal / Hexagonal / Hexagonale



INCH



COD.	A (inch)	B (inch)	HEX 1 (mm)	HEX 2 (mm)	Ø 1 (mm)	L (mm)	L1 (inch)	L2 (mm)		
55344	5/32	0,032	4	-	26	185	4	85	16	
55345	7/32	0,04	5	-	34	230	5	105	8	
55346	1/4	0,046	6	-	36	240	6	115		•
55347	5/16	0,063	8	11	40	330	8	130	6	
55348	25/64	0,063	8	11	40	330	8	130	6	
55349	15/32	0,08	10	16	40	380	10			-

DIN 5265 | Modelo registrado / Registered model / Modèle enregistré

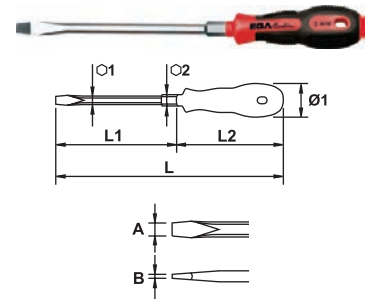
CARACTERÍSTICAS / FEATURES / CARACTÉRISTIQUES



Hexagonal / Hexagonal / Hexagonale



ELECTRICISTA / ELECTRICIAN / ELECTRICIEN / ELEKTRIK / PER ELETTRICISTI / ELETRICISTA / ЭЛЕКТРИЧЕСКАЯ
MM

COD.	A (mm)	B (mm)	Ø 1 (mm)	Ø 2 (mm)	L (mm)	L1 (mm)	L2 (mm)			
66420	2,5	0,4	2,5	-	160	75				
66421	3	0,5	3	26	145	60	85	16		•
66422					185	100				
66423					230	125				
66424	4	0,8	4	34	255	150				•
66411				34	405	300	105	8		•
66425					255	150				•
66412	5,5	1	5,5		405	300				•
66426	6,5	1,2	6,5	36	265	150	115	6		
66427	8	1,2	8	40	305	175	130	6		

DIN 5265 | Modelo registrado / Registered model / Modèle enregistré

INCH

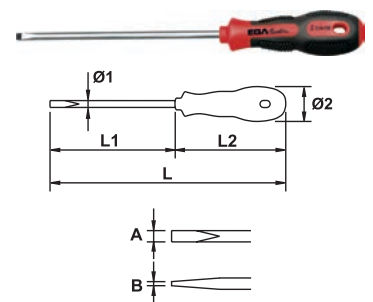
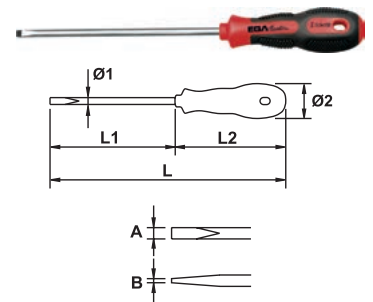
COD.	A (inch)	B (inch)	Ø 1 (mm)	Ø 2 (mm)	L (mm)	L1 (inch)	L2 (mm)			
55352	3/32	0,016	2,5	-	160	3				
55354	1/8	0,02	3	26	185	4	85	16		•
55355					230	5				
55356	5/32	0,032	4		255	6				
55357				34	405	12	105	8		•
55358					255	6				•
55359	7/32	0,04	5,5		405	12				•
55360	1/4	0,046	6,5	36	265	6	115	6		
55361	5/16	0,063	8	40	305	7	130	6		

DIN 5265 | Modelo registrado / Registered model / Modèle enregistré

05

**DESTORNILLADORES
SCREWDRIVERS
TOURNEVIS
SCHRAUBENZIEHER
CACCIAVITI
CHAVES DE FENDA
OTBEPCKH**



EGA

■ 1000V

■ MM

COD.	A (mm)	B (mm)	Ø 1 (mm)	Ø 2 (mm)	Ø 3 (mm)	L (mm)	L1 (mm)	L2 (mm)			
76620	2,5	0,4	4,4	6,1	26	160	75	85	16		
76621	3	0,5	4,4	6,1	26	185	100	85	16		
76622	4	0,8	5,4	7	34	230	125	105	8		
76623	5,5	1	6,4	8,8	34	230	125	105	8		
76624	5,5	1	6,4	8,8	34	255	150	115	8		
76625	6,5	1,2	8,4	11	36	265	175	130	6		
76626	8	1,2	9,4	12,3	40	305	175	130	6		
76627	10	1,6	11,4	15	40	330	200	130	6		

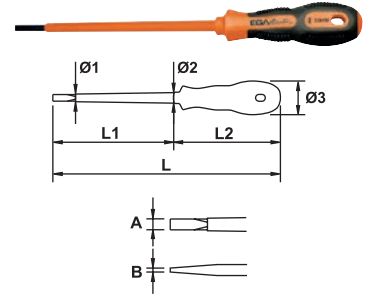

1000V | DIN 5265 | IEC 60900 | Modelo registrado / Registered model / Modèle enregistré

■ INCH

COD.	A (inch)	B (inch)	Ø 1 (mm)	Ø 2 (mm)	Ø 3 (mm)	L (mm)	L1 (inch)	L2 (mm)			
75063	3/32	0,016	4,4	6,1	26	160	3	85	16		
75064	1/8	0,02	4,4	6,1	26	185	4	85	16		
75065	5/32	0,032	5,4	7	34	230	5	105	8		
75066	7/32	0,04	6,4	8,8	34	230	5	105	8		
75067	7/32	0,04	6,4	8,8	34	255	6	115	8		
75068	1/4	0,046	8,4	11	36	265	7	130	6		
75069	5/16	0,046	9,4	12,3	40	305	7	130	6		
75081	25/64	0,063	11,4	15	40	330	8	130	6		

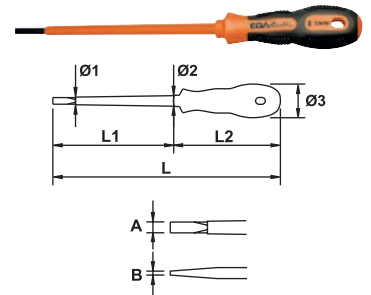

1000V | DIN 5265 | IEC 60900 | Modelo registrado / Registered model / Modèle enregistré

■ PHILIPS

COD.		Ø 1 (mm)	Ø 2 (mm)	L (mm)	L1 (mm)	L2 (mm)			
66438	PH-0	3	26	145	60	85	16		
66439	PH-1	5	34	205	100	105	8		
66437	PH-1	5	34	405	300	105	8		
66440	PH-2	6	36	240	125	115	6		
66443	PH-2	6	36	415	300	115	6		
66441	PH-3	8	40	280	150	130	6		
66442	PH-4	10	40	330	200	130	6		

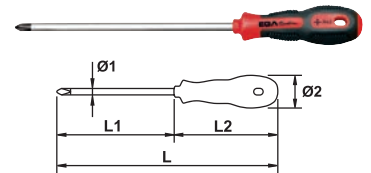

| DIN 5262 | Modelo registrado / Registered model / Modèle enregistré

COD.		HEX 1 (mm)	HEX 2 (mm)	Ø 1 (mm)	L (mm)	L1 (mm)	L2 (mm)			
66444	PH-1	5	8	34	205	100	105	8		
66445	PH-2	6	11	36	240	125	115	6		
66446	PH-3	8	16	40	280	150	130	6		
66447	PH-4	10	16	40	330	200	130	6		

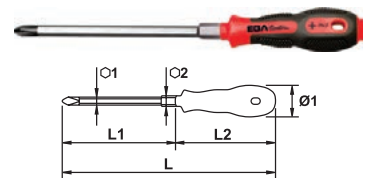







| DIN 5262 | Modelo registrado / Registered model / Modèle enregistré

CARACTERÍSTICAS / FEATURES / CARACTÉRISTIQUES



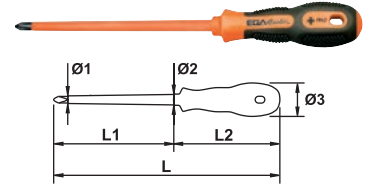

Hexagonal / Hexagonal / Hexagonale

EGA
1000V

COD.		Ø 1 (mm)	Ø 2 (mm)	Ø 3 (mm)	L (mm)	L1 (mm)	L2 (mm)			
76628	PH-0	4,4	5	26	145	60	85	16		
76738	PH-1	6,4	7,6	34	185	80	105	8		
76629					205	100				
76630	PH-2	7,4	9,6	36	240	125	115			
76631	PH-3	9,4	12,3	40	280	150	130	6		
76632	PH-4				330	200				







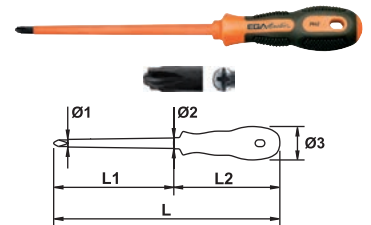



 | **1000V** | **DIN 5262** | **IEC 60900** | Modelo registrado / Registered model / Modèle enregistré

PLANO-PHILIPS PARA BORNES ELÉCTRICOS / SLOTTED-PHILIPS FOR TERMINAL SCREWS / PHILIPS-À FENTE POUR BORNES ÉLECTRIQUES / SCHLITZ-PHILIPS SCHRAUBENDREHER FÜR SCHRAUBKLEMMEN / TAGLIO-PHILIPS PER TERMINALI ELETTRICI / FENDA-PHILIPS PARA BORNES ELÉCTRICOS / ОТБЕТКА КРЕСТОВАЯ КЛЕММНАЯ PH
1000V





COD.		Ø 1 (mm)	Ø 2 (mm)	Ø 3 (mm)	L (mm)	L1 (mm)	L2 (mm)			
79163		PH-1	6,4	7,6	34	205	100	105	8	
79164										

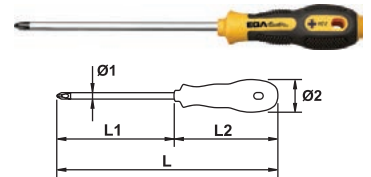

 | **1000V** | **IEC 60900** | Modelo registrado / Registered model / Modèle enregistré

POZIDRIV®*

COD.		Ø 1 (mm)	Ø 2 (mm)	L (mm)	L1 (mm)	L2 (mm)			
66456	PZ-0	3	26	145	60	85	16		
66457	PZ-1	5	34	205	100	105	8		
66472				405	300				
66458	PZ-2	6	36	240	125	115	6		
66473				415	300				
66459	PZ-3	8	40	280	150	130			
66460	PZ-4	10		330	200				

 | **DIN 5262** | Modelo registrado / Registered model / Modèle enregistré

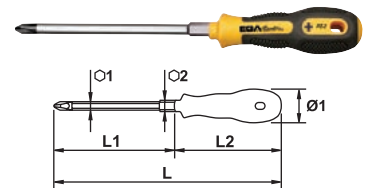





COD.		HEX 1 (mm)	HEX 2 (mm)	Ø 1 (mm)	L (mm)	L1 (mm)	L2 (mm)		
66462	PZ-1	5	8	34	205	100	105	8	
66463	PZ-2	6	11	36	240	125	115		
66464	PZ-3	8		40	278	150	128	6	
66465	PZ-4	10	16	40	328	200			



 | **DIN 5262** | Modelo registrado / Registered model / Modèle enregistré

CARACTERÍSTICAS / FEATURES / CARACTÉRISTIQUES

Hexagonal / Hexagonal / Hexagonale

1000V

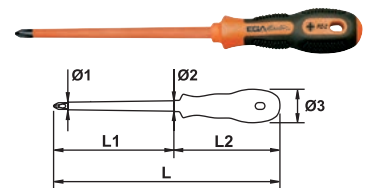
COD.		Ø 1 (mm)	Ø 2 (mm)	Ø 3 (mm)	L (mm)	L1 (mm)	L2 (mm)			
76633	PZ-0	4,4	5	26	145	60	85	16		
76634	PZ-1	6,4	7,6	34	205	100	105	8		
76635	PZ-2	7,4	9,6	36	240	125	115			
76636	PZ-3	9,4	12,3	40	280	150	130	6		
76637	PZ-4				330	200				





 | **1000V** | **DIN 5262** | **IEC 60900** | Modelo registrado / Registered model / Modèle enregistré

*Para tornillos POZIDRIV® (Marca registrada por European Ind. Serv. Ltd.) / *For screws POZIDRIV® (European Ind. Serv. Ltd. registered trademark) / *Pour vis POZIDRIV® (Marque enregistrée par European Ind. Serv. Ltd.)

EGA







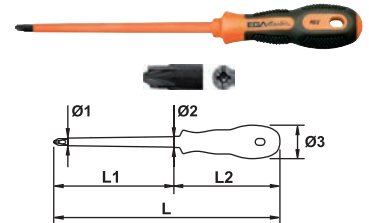

PLANO-POZIDRIV® PARA BORNES ELÉCTRICOS / SLOTTED-POZIDRIV® FOR TERMINAL SCREWS / POZIDRIV® - À FENTE POUR BORNES ÉLECTRIQUES / SCHLITZ-POZIDRIV® SCHRAUBENDREHER FÜR SCHRAUBKLEMMEN / TAGLIO-POZIDRIV® PER TERMINALI ELETTRICI / FENDA-POZIDRIV® PARA BORNES ELÉCTRICOS / ОТВЕРТКА КРЕСТОВАЯ КЛЕММНАЯ POZIDRIV®

1000V

COD.		Ø 1 (mm)	Ø 2 (mm)	Ø 3 (mm)	L (mm)	L1 (mm)	L2 (mm)		
79165		PZ-1	6,4	7,6	34	205	100	105	8
79166		PZ-2	7,4	9,6	36	240	125	115	6





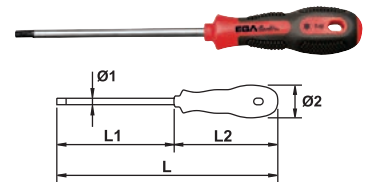

 **1000V** | IEC 60900 | Modelo registrado / Registered model / Modèle enregistré

TORX®

COD.		Ø 1 (mm)	Ø 2 (mm)	L (mm)	L1 (mm)	L2 (mm)			
66474	T-6			135	50				
66475	T-7								
66476	T-8	3	26			85			
66477	T-9			160	75			16	
66478	T-10								
66479	T-15	4		180					
66480	T-20								
66481	T-25	5	34	205	100	105			
66482	T-27			220	115			8	
66483	T-30	6	36	240		115			
66484	T-40	7		255	125				
66485	T-45	8	40	280	150	130	6		
66486	T-50	10		305	175				

 **DIN 5262** | Modelo registrado / Registered model / Modèle enregistré

1000V





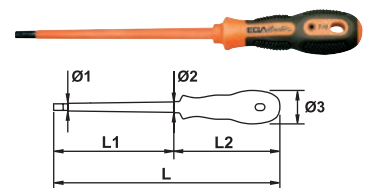

COD.		Ø 1 (mm)	Ø 2 (mm)	Ø 3 (mm)	L (mm)	L1 (mm)	L2 (mm)			
76638	T-6		8		135	50				
76639	T-7									
76640	T-8	4,4		26			85			
76641	T-9		5		160	75		16		
76642	T-10									
76643	T-15	5,8			180					
76644	T-20		8	34	205	100	105			
76645	T-25	6,4			220	115		8		
76646	T-27		9,6	36	240		115			
76647	T-30	7,4				125				
76648	T-40	8,7	12,3		255					
76649	T-45	9,4		40	280	150	128	6		
76650	T-50	11,4	15		305	175				

 **1000V** | DIN 5262 | IEC 60900 | Modelo registrado / Registered model / Modèle enregistré





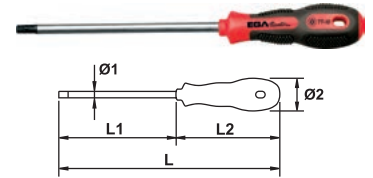

- *Para tornillos POZIDRIV® (Marca registrada por European Ind. Serv. Ltd.) / *For screws POZIDRIV® (European Ind. Serv. Ltd. registered trademark) / *Pour vis POZIDRIV® (Marque enregistrée par European Ind. Serv. Ltd.)
- *Para tornillos TORX® (Marca registrada por Acument Intellectual Properties, LLC, Troy, Mich., US) / *For screws TORX® (Acutment Intellectual Properties, LLC, Troy, Mich., US registered trademark) / *Pour vis TORX® (Marque enregistrée par Acument Intellectual Properties, LLC, Troy, Mich., US)

EGA
TAMPER TORX

COD.		Ø 1 (mm)	Ø 2 (mm)	L (mm)	L1 (mm)	L2 (mm)			
66487	TT-6				135	50			
66488	TT-7								
66489	TT-8	3							
66490	TT-9		26			85	16		
66491	TT-10				160	75			
66492	TT-15								
66493	TT-20	4			185	100			
66494	TT-25				205				
66495	TT-27	5	34		220	115	105	8	
66496	TT-30	6	36		240		115		
66497	TT-40	7			255	125			
66498	TT-45	8	40		280	150	130	6	
66499	TT-50	10			305	175			







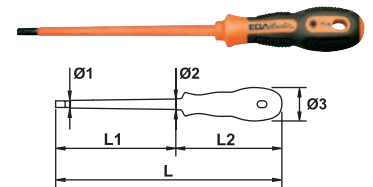

 | Modelo registrado / Registered model / Modèle enregistré

1000V

COD.		Ø 1 (mm)	Ø 2 (mm)	Ø 3 (mm)	L (mm)	L1 (mm)	L2 (mm)		
75037	TT-6					135	50		
75038	TT-7		8						
75039	TT-8	4,4		26			85		
75040	TT-9		5					16	
75041	TT-10				160	75			
75042	TT-15				180				
75043	TT-20	5,8	8		205	100	105		
75044	TT-25			34					
75045	TT-27	6,4			220	115		8	
75046	TT-30	7,4	9,6		240		115		
75047	TT-40	8,7			255	125			
75048	TT-45	9,4	12,3	40	280	150	128	6	
75049	TT-50	11,4	15		305	175			





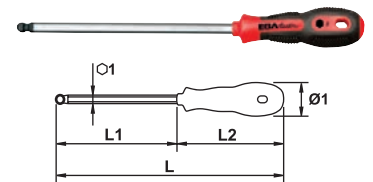

 | IEC 60900 | Modelo registrado / Registered model / Modèle enregistré

PUNTA ESFERA / BALL TIP / TÊTE SPHÉRIQUE / KUGELKOPF / TESTA SFERICA / PONTA ESFERICA / С ШАРОВОЙ ГОЛОВКОЙ
MM

COD.	HEX 1 (mm)	Ø 1 (mm)	L (mm)	L1 (mm)	L2 (mm)			
66501	2,5			160	75			
66502	3	26			85	16		
66503	4			185	100			

 | Modelo registrado / Registered model / Modèle enregistré

INCH

COD.	HEX 1 (inch)	Ø 1 (mm)	L (mm)	L1 (inch)	L2 (mm)			
55364	1/8	26	160	3	85	16		
55365	5/32		185					
55362	13/64	34	205	4	105	8		
55368	5/16							
55369	25/64	40	280	6	130	6		

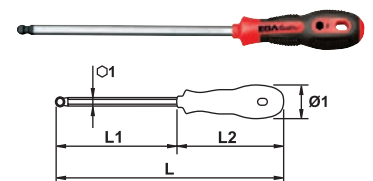



 | Modelo registrado / Registered model / Modèle enregistré

EGA

HEXAGONAL ALLEN

1000V

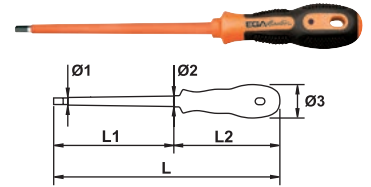

MM

COD.		Ø 1 (mm)	Ø 2 (mm)	Ø 3 (mm)	L (mm)	L1 (mm)	L2 (mm)		
74710	2,5								
74711	3	4,4	6	26	160	75	85	16	
74712	4	5,8	8		185	100		8	•
74713	5	6,4		34	205		105		
74714	6	7,8	11,2		230	125		6	
74715	8	9,8	13,4	40	280	150	130		-



 **1000V** | ICE 60900 | Modelo registrado / Registered model / Modèle enregistré



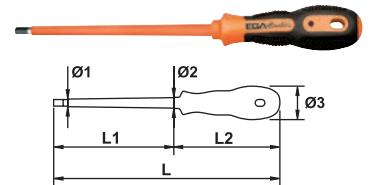

INCH

COD.		Ø 1 (mm)	Ø 2 (mm)	Ø 3 (mm)	L (mm)	L1 (inch)	L2 (mm)		
75083	1/8	4,4	6	26	160	3	85	16	
75084	5/32	5,8	8		185	4		8	•
75131	13/64	6,4		34	205		105		
75097	5/16	9,8	13,4	40	280	6	130	6	-



 **1000V** | ICE 60900 | Modelo registrado / Registered model / Modèle enregistré

ROBERTSON

COD.			Ø 1 (mm)	Ø 2 (mm)	L (mm)	L1 (mm)	L2 (mm)			
66530	1	2,4	4	26	185	100	85	16		
66531	2	2,8	5	34	230	125	105	8	•	•
66532	3	3,4	6	36	265	150	115	6		•

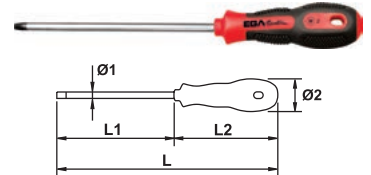



 **1000V** | Modelo registrado / Registered model / Modèle enregistré

CARROCERO / STUBBY / TOM POUCE / SCHRAUBENDREHER, KURZE FORM / CACCIAVITI NANI / COTOS / КОРОТКАЯ

ELECTRICISTA / ELECTRICIAN / ELECTRICIEN / ELEKTRIK / PER ELETTRICISTI / ELETRICISTA / ЭЛЕКТРИЧЕСКАЯ

MM

COD.	A (mm)	B (mm)	Ø 1 (mm)	Ø 2 (mm)	L (mm)	L1 (mm)	L2 (mm)		
66529	4	0,8	4	40	85	25	25	20	•
66525	5,5	1,2	5,5				60		

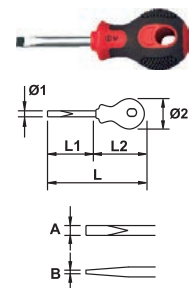

 **1000V** | DIN 5265 | Modelo registrado / Registered model / Modèle enregistré

INCH

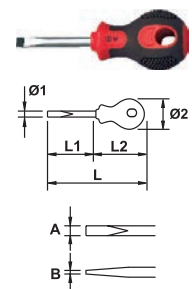

COD.	A (inch)	B (inch)	Ø 1 (mm)	Ø 2 (mm)	L (mm)	L1 (inch)	L2 (mm)		
55371	7/32	0,046	5,5	40	85	1	60	20	•



 **1000V** | DIN 5265 | Modelo registrado / Registered model / Modèle enregistré

EGA

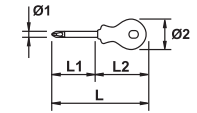

PHILIPS

COD.		Ø 1 (mm)	Ø 2 (mm)	L (mm)	L1 (mm)	L2 (mm)		
67192	PH-1	5	40	85	25	60	20	•
66526	PH-2	6						



• | DIN 5262 | Modelo registrado / Registered model / Modèle enregistré

POZIDRIV®*

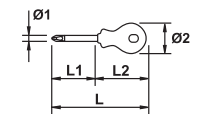

COD.		Ø 1 (mm)	Ø 2 (mm)	L (mm)	L1 (mm)	L2 (mm)		
67193	PZ-1	5	40	85	25	60	20	•
66527	PZ-2	6						



• | DIN 5262 | Modelo registrado / Registered model / Modèle enregistré

DE VASO / SOCKET SCREWDRIVER / CLÉ À DOUILLE EMMANCHÉE / 6-KANT STECKSCHLÜSSEL / BUSSOLE / DE CAIXA / ОТВЕРТКА С ГОЛОВКОЙ

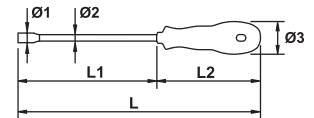

MM

COD.		Ø 1 (mm)	Ø 2 (mm)	Ø 3 (mm)	L (mm)	L1 (mm)	L2 (mm)		
66510	4	8							
66511	5	8,5	5	34	255	150	105	8	
66512	5,5								
66513	6								
66509	6,5	10	6	36	275	160	115		
66514	7	11			290				
66515	8								•
66516	9	14	8					6	
66517	10	15							
66518	11			40	305	175	130		
66519	12	17							
66520	13	19	9						
66521	14	20							



• | Modelo registrado / Registered model / Modèle enregistré

INCH

COD.		Ø 1 (mm)	Ø 2 (mm)	Ø 3 (mm)	L (mm)	L1 (inch)	L2 (mm)		
55373	5/32	8							
55374	3/16	8,5	5	34	255	6	105	8	
55375	7/32								
55376	1/4	10	6	36	275		115		
55378	5/16		8						
55379	11/32	14	7						•
55372	3/8		8					6	
55380	25/64	15		40	305	7	130		
55385	7/16	20	9						
55382	15/32	17							
55383	1/2	19	7						

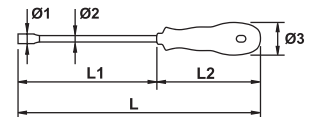

• | Modelo registrado / Registered model / Modèle enregistré

05

**DESTORNILLADORES
SCREWDRIVERS
TOURNEVIS
SCHRAUBENZIEHER
CACCIAVITI
CHAVES DE FENDA
OTBEPCKH**



EGA

■ 1000V

■ MM

COD.		Ø 1 (mm)	Ø 2 (mm)	Ø 3 (mm)	L (mm)	L1 (mm)	L2 (mm)		
74698	4								
74699	5	11	7,5	34	255	150	105	8	
74700	5,5								
74701	6				275	160			
74702	7	12,5	8,5	36	290		115		
74703	8								
74704	9	16	10,5						•
74705	10							6	
74706	11			40	305	175	130		
74707	12	19							
74708	13		11,5						
74709	14	21							

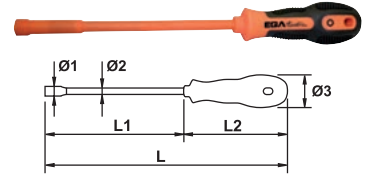

⚡ 1000V | IEC 60900 | Modelo registrado / Registered model / Modèle enregistré

■ INCH

COD.		Ø 1 (mm)	Ø 2 (mm)	Ø 3 (mm)	L (mm)	L1 (inch)	L2 (mm)		
75132	5/32								
74984	3/16	11	7,5	34	255	6	105	8	
75133	7/32								
74985	1/4	12,5	8,5	36	275		115		
74986	5/16								
74987	3/8	16	10,5						•
75136	25/64			40	305	7	130	6	
74988	7/16	19							
75138	15/32		11,5						
74989	1/2	21							

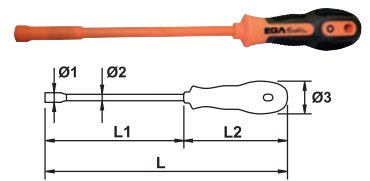

⚡ 1000V | IEC 60900 | Modelo registrado / Registered model / Modèle enregistré

■ MM

COD.						
74664	9					
74665	10					
74666	11					
74667	12	11		130	115	6
74669	14					
74670	17					



⚡ 1000V | IEC 60900

■ INCH



COD.						
74671	3/16					
74672	1/4					
74673	5/16					
74674	3/8					
74675	7/16	11		5	115	6
74676	1/2					
74677	9/16					
74678	5/8					







⚡ 1000V | IEC 60900

Si no encuentra el artículo que necesita, consúltenos en info@egamaster.com o en www.egamaster.com
If you can't find the item you look for, please ask us in info@egamaster.com or in www.egamaster.com
Si vous ne trouvez pas l'article que vous desirez, consultez-nous à info@egamaster.com ou à www.egamaster.com

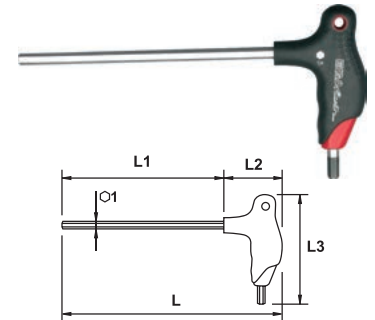

EGA
T - MASTERTORK
HEXAGONAL ALLEN
MM

COD.	 mm	L (mm)	L1 (mm)	L2 (mm)	L3 (mm)		
66571	2,5						
66572	3	165	125	40	60	16	
66573	4						•
66574	5		150				
66575	6	200		50	80	8	
66576	8	240	175				
66577	10	265	200	65	100	6	-



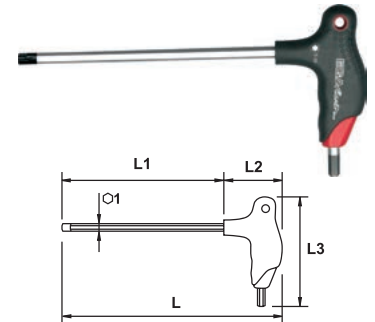

TORX®*

COD.		HEX 1 (mm)	L (mm)	L1 (mm)	L2 (mm)	L3 (mm)		
66581	T-6							
66582	T-7							
66583	T-8	3						
66584	T-9		165	125	40	60	16	
66585	T-10							•
66586	T-15	3,5						
66587	T-20	4						
66588	T-25	4,5						
66589	T-27	5,5	200	150	50	80	8	
66590	T-30	6						
66591	T-40	7						
66592	T-45	8	240	175	65	100	6	-
66593	T-50	9						

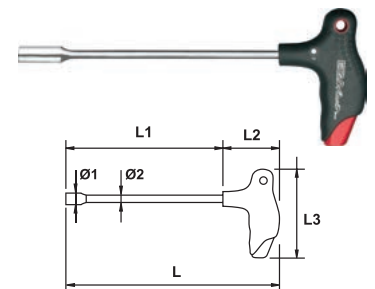
DE VASO / SOCKET SCREWDRIVER / CLÉ À DOUILLE EMMANCHÉE / 6-KANT STECKSCHLÜSSEL / BUSSOLE / DE CAIXA / ОТВЕРТКА С ГОЛОВКОЙ
MM

COD.	 mm	Ø 1 (mm)	Ø 2 (mm)	L (mm)	L1 (mm)	L2 (mm)	L3 (mm)		
66596	5	8,5	5	200	150				
66597	6	10		210	160	50	80	8	
66598	7	11	6	225					
66599	8	13							•
66600	9	14	8						
66601	10	15		240	175				
66602	11	17				65	100	6	
66603	12	17	9						
66604	13	19							

INCH

COD.	 inch	Ø 1 (mm)	Ø 2 (mm)	L (mm)	L1 (mm)	L2 (mm)	L3 (mm)		
55397	5/16	13							
55399	25/64	15	8	240	7	65	100	6	•
55401	15/32	17	9						

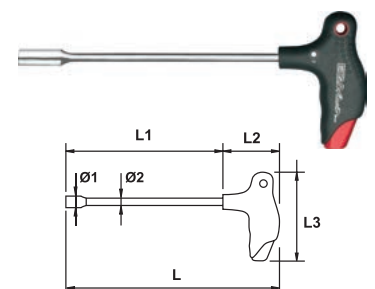

*Para tornillos TORX® (Marca registrada por Acument Intellectual Properties, LLC, Troy, Mich., US) / *For screws TORX® (Acument Intellectual Properties, LLC, Troy, Mich., US registered trademark) / *Pour vis TORX® (Marque enregistrée par Acument Intellectual Properties, LLC, Troy, Mich., US)



EGA
MASTERPUNCH - ALL THROUGH

Sistema de punta antideslizante **NON-SLIP** y magnética / *NON-SLIP antislippery magnetic tip* / *NON-SLIP pointe brunie antidérapante et magnétique* / *NON-SLIP Anti-Rutsch-Spitze*
 Punta antiscivolo **NON-SLIP** / *Sistema de ponta antideslizante de chave NON-SLIP* / *Нескользкий магнитный наконечник*



Varilla pasante, permite el golpeo en su parte superior / *Go-through bar enables hammering on the screwdriver's upper side* / *Tige traversante permettant le frapper sur la partie supérieure du manche* / *Vorstecker mit Schlagfesten Griff* / *Cacciavite a lame passante a battere* / *Chave de fenda - haste interna, permite pancada na sua parte superior* / *Проходящий через ручку стержень позволяет наносить удары по верхней части отвертки*



MECÁNICO / SLOTTED / MECANICIEN / FÜR SCHLITZSCHRAUBEN / PER MECCANICI / MECÁNICO / ПЛОСКАЯ
MM

COD.	A (mm)	B (mm)	HEX 1 (mm)	HEX 2 (mm)	Ø 1 (mm)	L (mm)	L1 (mm)	L2 (mm)		
66551	6,5	1,2	6		35	235	125	110		
66552	8		8	11	39	270	150	120	6	●
66553	10	1,6				295	175			

CARACTERÍSTICAS / FEATURES / CARACTÉRISTIQUES

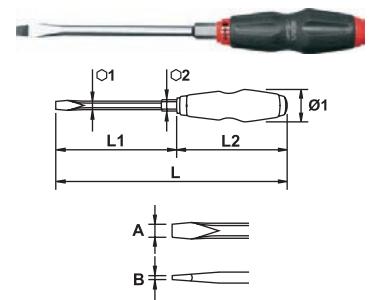
Hexagonal / Hexagonal / Hexagonale





INCH

COD.	A (inch)	B (inch)	HEX 1 (mm)	HEX 2 (mm)	Ø 1 (mm)	L (mm)	L1 (inch)	L2 (mm)		
55405	5/16	0,046				270	6			
55406	25/64	0,063	8	11	39	295	7	120	6	●

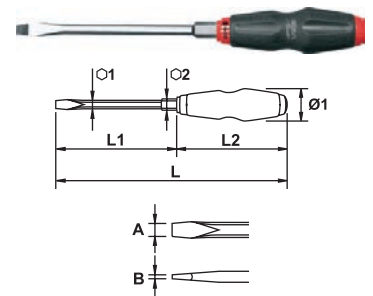
CARACTERÍSTICAS / FEATURES / CARACTÉRISTIQUES

Hexagonal / Hexagonal / Hexagonale





PHILIPS

COD.		HEX 1 (mm)	HEX 2 (mm)	Ø 1 (mm)	L (mm)	L1 (mm)	L2 (mm)		
66559	PH-2	6		35	235	125	110		
66560	PH-3	8	11	39	270	150	120	6	●

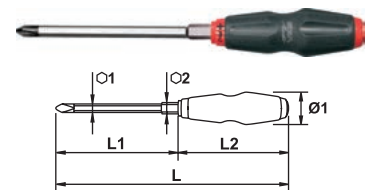
CARACTERÍSTICAS / FEATURES / CARACTÉRISTIQUES

Hexagonal / Hexagonal / Hexagonale

POZIDRIV®*

COD.		HEX 1 (mm)	HEX 2 (mm)	Ø 1 (mm)	L (mm)	L1 (mm)	L2 (mm)		
66565	PZ-2	6		35	235	125	110		
66566	PZ-3	8	11	39	270	150	120	6	●

CARACTERÍSTICAS / FEATURES / CARACTÉRISTIQUES

Hexagonal / Hexagonal / Hexagonale

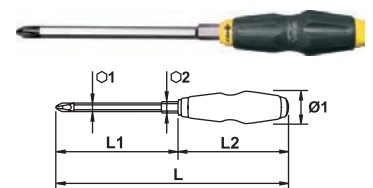

*Para tornillos POZIDRIV® (Marca registrada por European Ind. Serv. Ltd.) / *For screws POZIDRIV® (European Ind. Serv. Ltd. registered trademark) / *Pour vis POZIDRIV® (Marque enregistrée par European Ind. Serv. Ltd.)

EGA

ROTORK

MECÁNICO / SLOTTED / MECANICIEN / FÜR SCHLITZSCHRAUBEN / PER MECCANICI / MECÂNICO / ПЛОСКАЯ

MM

COD.	A (mm)	B (mm)	Ø 1 (mm)	Ø 2 (mm)	L (mm)	L1 (mm)	L2 (mm)			
66874	3	0,5	3	22	155	80	75	16		
66875	4	0,8	4		175	100				
66876	5,5	1	5	31	205	125	105	8		
66877					230					
66878	6,5	1,2	6	35	255	200	118	6		
66879	268		150							
66880	8	7	35	318	200	118	6			
66881	10	1,6								
66882	12	2	10	365	250	115	6			
67102	14	2,5								

DIN 5265

INCH

COD.	A (inch)	B (inch)	Ø 1 (mm)	Ø 2 (mm)	L (mm)	L1 (inch)	L2 (mm)			
55408	1/8	0,02	3	22	155	3	75	16		
55409	5/32	0,032	4		175	4				
55410	7/32	0,04	5	31	205	5	105	8		
55411					230					
55413	1/4	0,046	6	35	255	8	118	6		
55414	268		150							
55415	5/16	7	35	318	200	118	6			
55416	25/64	0,063								
55417	15/32	0,080	10	365	10	115	6			

DIN 5265

MM

COD.	A (mm)	B (mm)	HEX 1 (mm)	HEX 2 (mm)	Ø 1 (mm)	L (mm)	L1 (mm)	L2 (mm)		
67104	4	0,8	4	-	22	175	100	75	16	
67105	5,5	1	5	11	31	230	125	105	8	
66883	6,5	1,2	6		240	150				
66884	8	8	35	315	200	115	6			
66885	10	1,6								
67106	12	2	10	365	250	115	6			
67107	14	2,5								

DIN 5265

CARACTERÍSTICAS / FEATURES / CARACTÉRISTIQUES

Hexagonal / Hexagonal / Hexagonale

INCH

COD.	A (inch)	B (inch)	HEX 1 (mm)	HEX 2 (mm)	Ø 1 (mm)	L (mm)	L1 (inch)	L2 (mm)		
55420	5/32	0,032	4	-	22	175	4	75	16	
55421	7/32	0,04	5	11	31	230	5	105	8	
55423	5/16	0,046	8		268	6				
55424	25/64	0,063	8	35	318	8	115	6		
55425	15/32	0,08	10							

DIN 5265

CARACTERÍSTICAS / FEATURES / CARACTÉRISTIQUES

Hexagonal / Hexagonal / Hexagonale

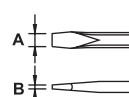
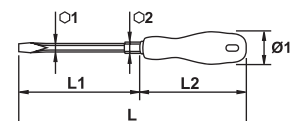
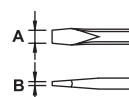
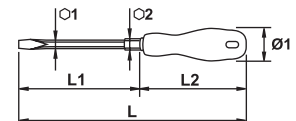
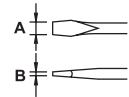
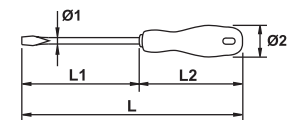
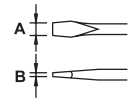
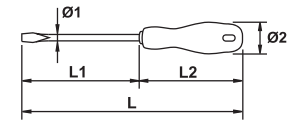

EGA

■ **ELECTRICISTA / ELECTRICIAN / ELECTRICIEN / ELEKTRIK / PER ELETRICISTI / ELETRICISTA / ЭЛЕКТРИЧЕСКАЯ**

■ **MM**

COD.	A (mm)	B (mm)	Ø 1 (mm)	Ø 2 (mm)	L (mm)	L1 (mm)	L2 (mm)			
67149	2,5	0,4	2,5		135	60				
66886	3	0,5	3	22	175	100	75			●
66887	4	0,8	4		200	125				
66888	5	1	5	31	255	150				●
66890	6	1,2	6		255	150				●
66891	8	1,6	8	35	290	175	105			
66892	10	1,6	10		315	200	115			

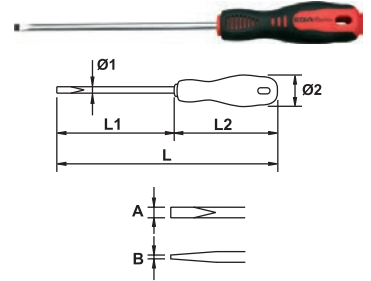

DIN 5265

■ **INCH**

COD.	A (inch)	B (inch)	Ø 1 (mm)	Ø 2 (mm)	L (mm)	L1 (inch)	L2 (mm)			
55428	3/32	0,016	2,5		135	2				●
55429	1/8	0,02	3	22	175	4	75			
55430	5/32	0,032	4		200	5				
55431	3/16	0,04	5	31	225	6				●
55432	1/4	0,046	6		255	6				●
55433	5/16	0,063	8	35	290	7	105			
55434	3/8	0,063	10		315	8	115			

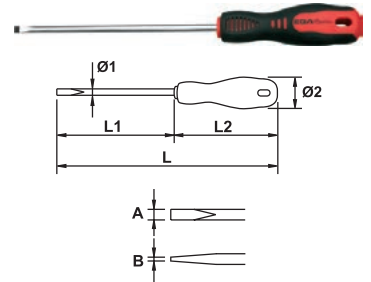

DIN 5265

■ **1000V**

■ **MM**

COD.	A (mm)	B (mm)	Ø 1 (mm)	Ø 2 (mm)	Ø 3 (mm)	L (mm)	L1 (mm)	L2 (mm)			
76730	-	2,5	0,4	4,4	6,1	22	135	60	75	16	●
76731	3	0,5					175	100			●
76651	4	0,8	5,4	7			230	125			●
76652	5,5	1	6,4	8,8	31		255	150	105	8	●
76653	6,5	1,2	7,8	11			290	175			●
76654	8	1,6	9,4	12,3	35		315	200	115	6	●
76732	-	10	1,6	11,4	15		315	200	115	6	●

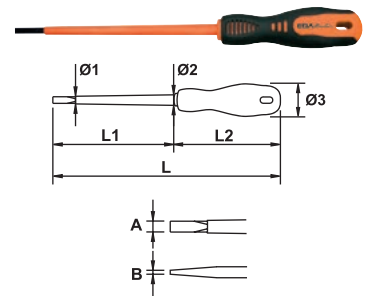

1000V | **DIN 5265** | **IEC 60900**

■ **INCH**

COD.	A (inch)	B (inch)	Ø 1 (mm)	Ø 2 (mm)	Ø 3 (mm)	L (mm)	L1 (inch)	L2 (mm)			
75172	3/32	0,016	4,4	6,1	22	135	2	75	16		
75173	1/8	0,02				175	4				
75174	5/32	0,032	5,4	7		230	5				
75175	3/16	0,04	6,4	8,8	31	255	6	105	8		●
75176	1/4	0,046	7,8	11		290	7				●
75177	5/16	0,063	9,4	12,3	35	315	8	115	6		●
75178	3/8	0,063	11,4	15		315	8	115	6		●

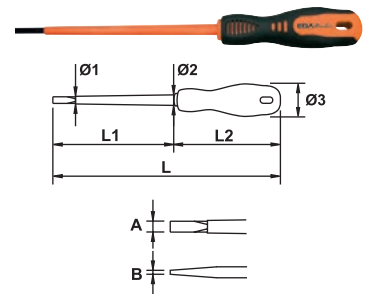

1000V | **DIN 5265** | **IEC 60900**

EGA

PHILIPS

COD.		Ø 1 (mm)	Ø 2 (mm)	L (mm)	L1 (mm)	L2 (mm)			
66897	PH-0	3	22	135	60	75	16		
66898	PH-1	4		205	100				-
66899	PH-2	5	31	230	125	105	8		
66900	PH-3	6		265	150				
67131	PH-4	10	35	315	200	115	6		-

DIN 5262

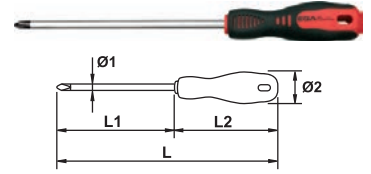

COD.		HEX 1 (mm)	HEX 2 (mm)	Ø 1 (mm)	L (mm)	L1 (mm)	L2 (mm)			
67053	PH-1	5	-	31	205	100	105	8		
66901	PH-2	6			243	125				-
66902	PH-3		11	35	268	150	118	6		-
67054	PH-4	8			318	200				-

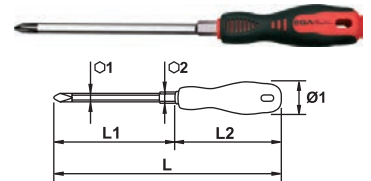

| DIN 5262

CARACTERÍSTICAS / FEATURES / CARACTÉRISTIQUES

Hexagonal / Hexagonal / Hexagonale

1000V

COD.		Ø 1 (mm)	Ø 2 (mm)	Ø 3 (mm)	L (mm)	L1 (mm)	L2 (mm)			
76655	PH-0	4,4	5	22	135	60	75	16		
76656	PH-1	6,4	8	31	205	100				
76657	PH-2	7,4	9,6		230	125	105	8		-
76658	PH-3			35	268	150	118	6		-
76735	PH-4	9,4	12,3		318	200				-

| DIN 5262 | IEC 60900

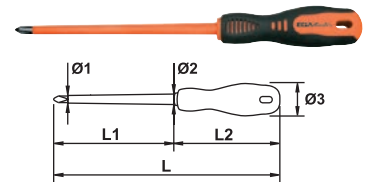

POZIDRIV®*

COD.		Ø 1 (mm)	Ø 2 (mm)	L (mm)	L1 (mm)	L2 (mm)			
66907	PZ-0	3	22	135	60	75	16		
66908	PZ-1	5		205	100				
66909	PZ-2	6	31	230	125	105	8		
66910	PZ-3	8		268	150				-
67064	PZ-4	10	35	318	200	118	6		-

DIN 5262

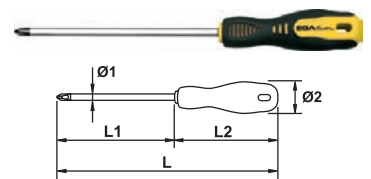

COD.		HEX 1 (mm)	HEX 2 (mm)	Ø 1 (mm)	L (mm)	L1 (mm)	L2 (mm)			
67167	PZ-1	5	-		215	100		8		
66911	PZ-2	6		35	240	125	115			
66912	PZ-3		11		265	150		6		-
67168	PZ-4	8			315	200				-

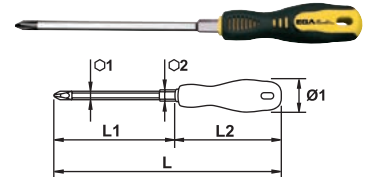

| DIN 5262





CARACTERÍSTICAS / FEATURES / CARACTÉRISTIQUES

Hexagonal / Hexagonal / Hexagonale

* Para tornillos POZIDRIV® (Marca registrada por European Ind. Serv. Ltd.) / * For screws POZIDRIV® (European Ind. Serv. Ltd. registered trademark) / * Pour vis POZIDRIV® (Marque enregistrée par European Ind. Serv. Ltd.)

EGA



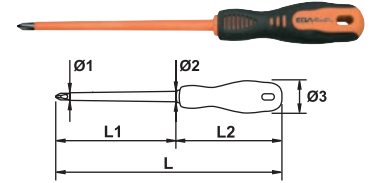

1000V

COD.			Ø 1 (mm)	Ø 2 (mm)	Ø 3 (mm)	L (mm)	L1 (mm)	L2 (mm)		
76659	-	PZ-0	4,4	5	22	135	60	75	16	
76660		PZ-1	6,4	8		205	100			
76661		PZ-2	7,4	9,6	31	230	125	105	8	•
76662		PZ-3	9,4	12,3		268	150			
76736	-	PZ-4		12,5	35	318	200	118	6	

 1000V | DIN 5262 | IEC 60900



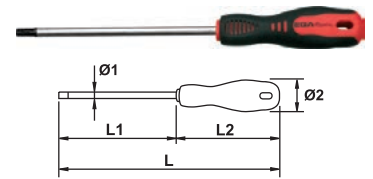

TORX®*

COD.		Ø 1 (mm)	Ø 2 (mm)	L (mm)	L1 (mm)	L2 (mm)			
66917	T-6								
66918	T-7	3		125	50				•
66919	T-8								
66920	T-9		22			75	16		
66921	T-10	4		150	75				
66922	T-15								•
66923	T-20			175	100				
66924	T-25	5		205					•
66925	T-27	6	31	220	115	105	8		•
66926	T-30			230	125				
66927	T-40	7		240					
67183	T-45	8	35	265	150	115	6		
67184	T-50	10		290	175				



TAMPER TORX

COD.		Ø 1 (mm)	Ø 2 (mm)	L (mm)	L1 (mm)	L2 (mm)		
65965	TT-6							
65966	TT-7	3		125	50			
65967	TT-8							
65968	TT-9		22			75	16	
65969	TT-10	4		150	75			
65972	TT-15							
65973	TT-20			175	100			•
65974	TT-25	5		205				
65994	TT-27	6	31	220	115	105	8	
65995	TT-30			230	125			
65996	TT-40	7		240				
65997	TT-45	8	35	265	150	115	6	
65998	TT-50	10		290	175			

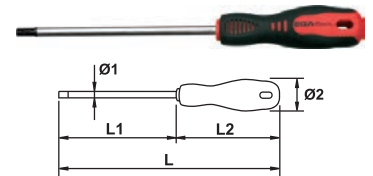







*Para tornillos TORX® (Marca registrada por Acument Intellectual Properties, LLC, Troy, Mich., US) / *For screws TORX® (Acument Intellectual Properties, LLC, Troy, Mich., US registered trademark) / *Pour vis TORX® (Marque enregistrée par Acument Intellectual Properties, LLC, Troy, Mich., US)

EGA



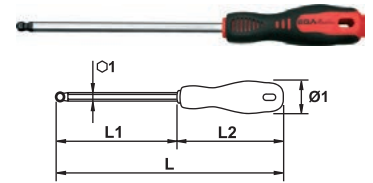

■ PUNTA ESFERA / BALL TIP / TÊTE SPHÉRIQUE / KUGELKOPF / TESTA SFERICA / PONTA ESFERICA / С ШАРОВОЙ ГОЛОВКОЙ

■ MM

COD.	HEX 1 (mm)	Ø 1 (mm)	L (mm)	L1 (mm)	L2 (mm)			
66928	2,5	22	150	75	75	16		
66929	3		175	100				
66930	4	31	205	100				
66931	5		230	125	105	8		
66932	6	35	265	150	115	6		
66933	8		265	150	115	6		-
67090	10							







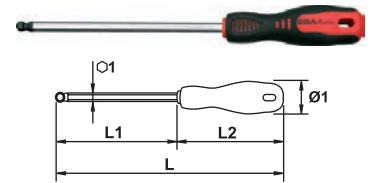

■ INCH

COD.	HEX 1 (inch)	Ø 1 (mm)	L (mm)	L1 (inch)	L2 (mm)			
55440	1/8	22	150	3	75	16		
55441	5/32	31	175	4				
55442	3/16		205	100				
55443	1/4	35	230	5	105	8		
55444	5/16		268	6	115	6		
55445	25/64							



■ ROBERTSON

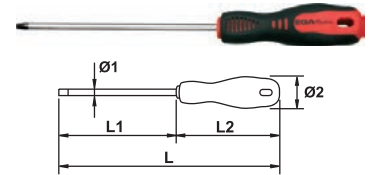

COD.		AF (mm)	Ø 1 (mm)	Ø 2 (mm)	L (mm)	L1 (mm)	L2 (mm)			
66934	1	2,4	5	22	175	100	75	16		
66935	2	2,8	6	31	230	125	105	8		
66936	3	3,4		255	150	105	6			



■ CARROCERO / STUBBY / TOM POUCE / SCHRAUBENDREHER, KURZE FORM / CACCIAVITI NANI / COTOS / КОРОТКАЯ

■ ELECTRICISTA / ELECTRICIAN / ELECTRICIEN / ELEKTRIK / PER ELETTRICISTI / ELETTRICISTA / ЭЛЕКТРИЧЕСКАЯ

■ MM

COD.	A (mm)	B (mm)	Ø 1 (mm)	Ø 2 (mm)	L (mm)	L1 (mm)	L2 (mm)		
66937	5,5	1,2	5,5	31	85	25	60	20	

 DIN 5265

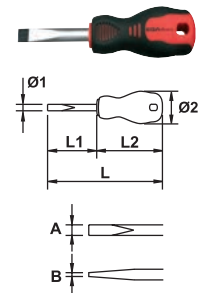

■ INCH

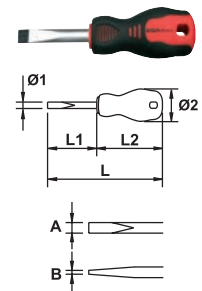

COD.	A (inch)	B (inch)	Ø 1 (mm)	Ø 2 (mm)	L (mm)	L1 (inch)	L2 (mm)		
55447	7/32	0,046	5,5	31	85	1	60	20	

 DIN 5265



EGA



PHILIPS

COD.		Ø 1 (mm)	Ø 2 (mm)	L (mm)	L1 (mm)	L2 (mm)		
67190	PH-1	5	31	85	25	60	20	•
66938	PH-2	5,5	31	85	25	60	20	•

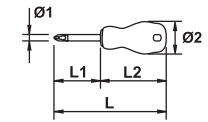
DIN 5262



POZIDRIV®*

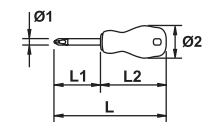

COD.		Ø 1 (mm)	Ø 2 (mm)	L (mm)	L1 (mm)	L2 (mm)		
67191	PZ-1	5	31	85	25	60	20	•
66939	PZ-2	6	31	85	25	60	20	•

DIN 5262



ACCESORIOS / ACCESSORIES / ACCESSOIRES / ERSATZTEILE / ACCESSORI / ACESSORIOS / ЗАПАСНЫЕ ЧАСТИ

PORTA-TORNILLOS MAGNÉTICOS / MAGNETIC SCREW HOLDERS / PORTE-TOURNEVIS MAGNÉTIQUE / MAGNETISCHER SCHRAUBENHALTER / PORTA INSERTI MAGNETICO / PORTA PARAFUSO MAGNÉTICO / МАГНИТНЫЙ ДЕРЖАТЕЛЬ ОТВЕРТКИ

COD.		Ó.D. mm	Válido para / Valid for / Valable pour	
66054	2-3	2-3	66420, 66421, 66422, 55352, 55354, 66438, 66456, 66474, 66475, 66476, 66477, 66478, 66488, 66489, 66490, 66491, 66501, 66502, 55364, 67149, 66886, 66887, 55428, 55429, 55430, 66897, 66907, 66917, 66918, 66919, 66928, 66929, 55440	•
66052	4-5	4-5	66400, 66401, 66423, 66424, 66411, 66439, 66437, 66479, 66480, 66481, 66482, 76620, 76621, 76628, 76638, 76639, 76640, 76641, 76642, 66457, 66472, 66530, 66531, 66503, 66874, 66875, 66888, 66889, 66890, 66891, 76730, 76731, 76651, 66899, 66908, 67167, 76633, 66919, 66920, 66921, 66922, 66923, 66924, 66930, 66931, 66934, 66935	•
66053	5,5-6	5,5-6	66425, 66412, 55358, 55359, 75063, 75064, 76622, 66444, 66483, 66458, 66473, 66532, 66892, 76652, 67053, 76655	•
66049	*	5,5-6,15	66440, 66443, 76623, 76624, 76738, 76629, 76643, 76644, 66909, 66900, 66911, 66925, 66932, 66936, 76653, 76656, 76634	•

* : Válido para puntas de 50 mm de longitud / Suitable for 50 mm length bits / Valable pour les pointes de 50 mm de longueur



Para trabajar con tornillos férricos
 To work with ferrous screws
 Pour travailler avec des vis ferriques



Para trabajar con tornillos inox
 To work with stainless steel screws
 Pour travailler avec des vis Inox



Válido para puntas de 50 mm de longitud
 Suitable for 50 mm length bits
 Valable pour les pointes de 50 mm de longueur

Aguanta hasta 2 kg de peso
 Supports up to 2 kg weight
 Supporte jusqu'à un poids de 2 Kg



Para ver las puntas disponibles consultar en el capítulo de puntas de destornillador del catálogo general o en www.egamaster.com
 To see the available bits check the bits chapter of general catalog or in www.egamaster.com
 Pour voir les pointes disponibles merci de consulter le chapitre des pointes de tournevis du catalogue général ou sur www.egamaster.com

SET

COD.	PCS.	
66047	4	45

PCS.	Composición / Composition / Composition	Descripción / Description / Description
4	66049, 66052, 66053, 66054	Porta-tornillos magnético / Magnetic screwholders / Porte-tournevis magnétique



* Para tornillos POZIDRIV® (Marca registrada por European Ind. Serv. Ltd.) / * For screws POZIDRIV® (European Ind. Serv. Ltd. registered trademark) / * Pour vis POZIDRIV® (Marque enregistrée par European Ind. Serv. Ltd.)

EGA

MICROTRONIC

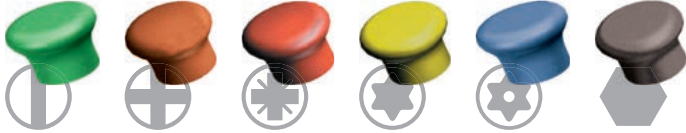

ELECTRICISTA / ELECTRICIAN / ELECTRICIEN / ELEKTRIK / PER ELETTRONICA / ELETRICISTA / ЭЛЕКТРИЧЕСКАЯ

MM

COD.	A (mm)	B (mm)	Ø 1 (mm)	Ø 2 (mm)	L (mm)	L1 (mm)	L2 (mm)		
66846	2	0,4	3	21	145	50	95	10	●
66847	3	0,5							
66848	4	0,8	4						

DIN 6265

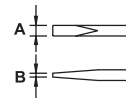
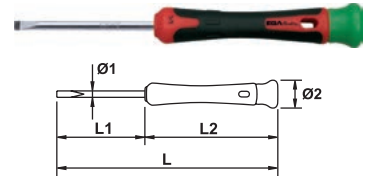

INCH

COD.	A (inch)	B (inch)	Ø 1 (mm)	Ø 2 (mm)	L (mm)	L1 (inch)	L2 (mm)		
55449	5/64	0,016	3	21	145	2	95	10	●
55450	1/8	0,02							
55451	5/32	0,03	4						

DIN 6265

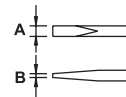
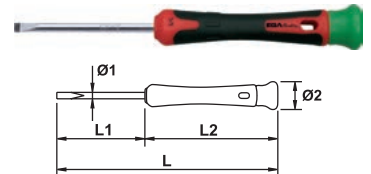

1000V

COD.	A (mm)	B (mm)	Ø 1 (mm)	Ø 2 (mm)	Ø 3 (mm)	L (mm)	L1 (mm)	L2 (mm)		
75156	1,5	0,23	1,5	3,1	19	140	40	100	10	●
75157	1,8	0,3	1,8	3,4						
75158	2	0,4	2	3,6		160	60			
75159	2,5	0,5	2,5	4,1		175	75			
75201	3	0,5	3	4,6						

1000V | DIN 7437 | IEC 60900

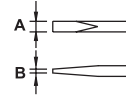
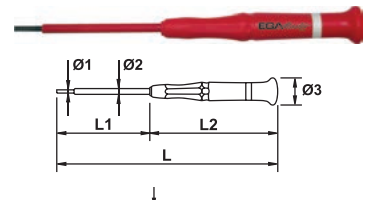

PHILIPS

COD.		Ø 1 (mm)	Ø 2 (mm)	L (mm)	L1 (mm)	L2 (mm)		
66850	PH-00	2	21	145	50	95	10	●
66851	PH-0	3						
66852	PH-1	4		170	75			

DIN 6262

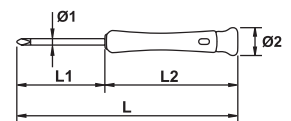
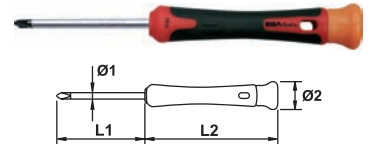



1000V

COD.		Ø 1 (mm)	Ø 2 (mm)	Ø 3 (mm)	L (mm)	L1 (mm)	L2 (mm)		
75202	PH-00	2,5	4,1	19	175	75	100	10	●
75203	PH-0	3	4,6						

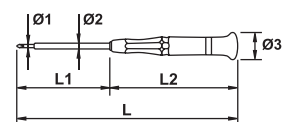
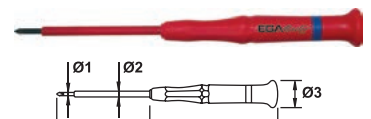
1000V | DIN 7438 | IEC 60900





EGA
POZIDRIV®*

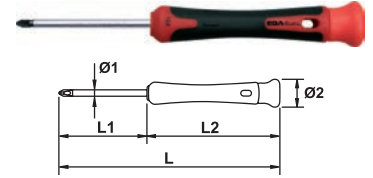

COD.		Ø 1 (mm)	Ø 2 (mm)	L (mm)	L1 (mm)	L2 (mm)		
66853	PZ-0	3		145	50			
66854	PZ-1	4	21	170	75	95	10	●

DIN 6262



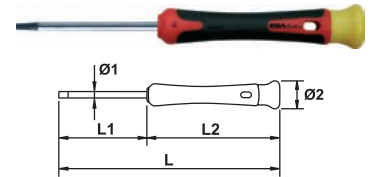

TORX®*

COD.		Ø 1 (mm)	Ø 2 (mm)	L (mm)	L1 (mm)	L2 (mm)		
66855	T-6	2			145	50		
66856	T-7			145	50			
66857	T-8							
66858	T-9	3	21			95	10	●
66859	T-10			170	75			
66860	T-15							
66861	T-20	4						

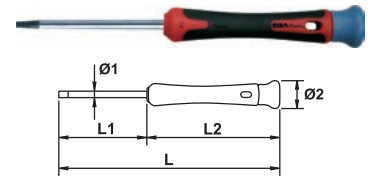



TAMPER TORX

COD.		Ø 1 (mm)	Ø 2 (mm)	L (mm)	L1 (mm)	L2 (mm)		
66866	TT-6	2			145	50		
66867	TT-7			145	50			
66868	TT-8							
66869	TT-9	3	21			95	10	●
66870	TT-10			170	75			
66871	TT-15							
66872	TT-20	4						

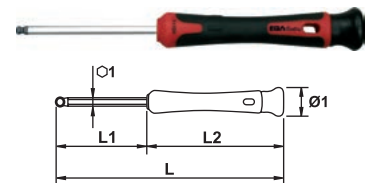
HEXAGONAL PUNTA ESFERA / HEXAGONAL BALL POINT / HEXAGONALE AVEC EMBOUT SPHÉRIQUE / HEXAGONAL KUGELKOPF / HEXAGONAL TESTA ESFERICA / HEXAGONAL COM PONTA ESFERICA / ШЕСТИГРАННИК С ШАРОВОЙ ГОЛОВКОЙ
MM

COD.		Ø 1 (mm)	L (mm)	L1 (mm)	L2 (mm)		
66862	1,5						
66863	2		145	50	95	10	●
66864	2,5	21					
66865	3		155	60			



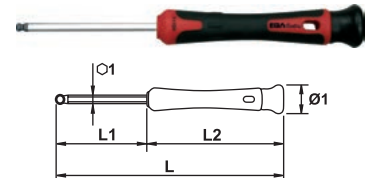

INCH

COD.		Ø 1 (mm)	L (mm)	L1 (inch)	L2 (mm)		
55454	1/16		145				
55455	5/64	21		2	95	10	●
55457	1/8		155				





- *Para tornillos POZIDRIV® (Marca registrada por European Ind. Serv. Ltd.) / *For screws POZIDRIV® (European Ind. Serv. Ltd. registered trademark) / *Pour vis POZIDRIV® (Marque enregistrée par European Ind. Serv. Ltd.)
- *Para tornillos TORX® (Marca registrada por Acument Intellectual Properties, LLC, Troy, Mich., US) / *For screws TORX® (Acument Intellectual Properties, LLC, Troy, Mich., US registered trademark) / *Pour vis TORX® (Marque enregistrée par Acument Intellectual Properties, LLC, Troy, Mich., US)



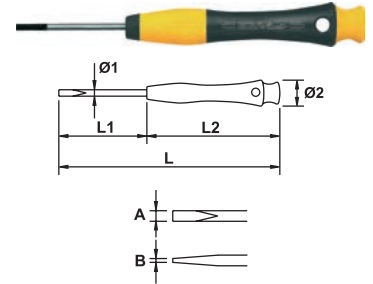

EGA
DESCARGA ELECTROSTÁTICA / ELECTROSTATIC DISCHARGE / DÉCHARGE ÉLECTROSTATIQUE / ELEKTROSTATISCHE ENTLADUNG / CACCIAVITI PER ELETTRONICA STATICA / DESCARGA ELECTROSTÁTICA / РАЗРЯЖАТЕЛЬ СТАТИЧЕСКОГО ЭЛЕКТРИЧЕСТВА
ESD
ELECTRICISTA / ELECTRICIAN / ELECTRICIEN / ELEKTRIK / PER ELETTRONICA / ELETRICISTA / ЭЛЕКТРИЧЕСКАЯ
MM

COD.	A (mm)	B (mm)	Ø 1 (mm)	Ø 2 (mm)	L (mm)	L1 (mm)	L2 (mm)			
64740	1	0,2			140	40		14		
64741	1,5	0,3	2					16		
64742	2	0,4						17		
64743	2,5	0,4	2,5	16			100	17	10	
64744	3	0,5	3		160	60		19		
64745	3,5	0,6	3,5					21		•
64746	4	0,7	4					24		

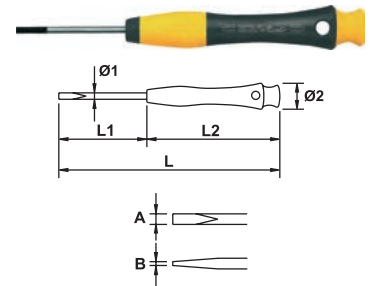



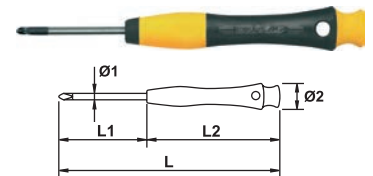

INCH

COD.	A (inch)	B (inch)	Ø 1 (mm)	Ø 2 (mm)	L (mm)	L1 (inch)	L2 (mm)			
55459		3/64			140			14		
55460	5/64	1/16	2					16		
55461		5/64						17		
55463	1/8	1/8	3	16		2	100	19	10	
55464	9/64	9/64	3,5		160			21		•
55465	5/32	5/32	4					24		





PHILIPS

COD.		Ø 1 (mm)	Ø 2 (mm)	L (mm)	L1 (mm)	L2 (mm)			
64747	PH00	2,5					17		
64748	PH0	3,0	16	160	60	100	19	10	
64749	PH1	4,0					24		•

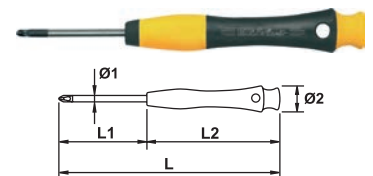

POZIDRIV**

COD.		Ø 1 (mm)	Ø 2 (mm)	L (mm)	L1 (mm)	L2 (mm)			
64753	PZ0	3,0	16	160	60	100	19	10	•
64754	PZ1	4,0					24		

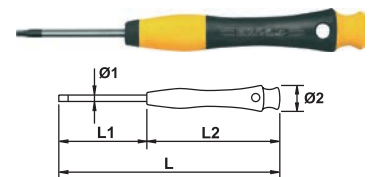

TORX**

COD.		Ø 1 (mm)	Ø 2 (mm)	L (mm)	L1 (mm)	L2 (mm)		
64756	T4							
64757	T5	2,5	16	140	40	100	14	10
64758	T6							





*Para tornillos POZIDRIV® (Marca registrada por European Ind. Serv. Ltd.) / *For screws POZIDRIV® (European Ind. Serv. Ltd. registered trademark) / *Pour vis POZIDRIV® (Marque enregistrée par European Ind. Serv. Ltd.)
 *Para tornillos TORX® (Marca registrada por Acument Intellectual Properties, LLC, Troy, Mich., US) / *For screws TORX® (Acument Intellectual Properties, LLC, Troy, Mich., US registered trademark) / *Pour vis TORX® (Marque enregistrée par Acument Intellectual Properties, LLC, Troy, Mich., US)

EGA

TAMPER TORX

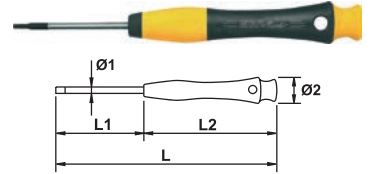
COD.		Ø 1 (mm)	Ø 2 (mm)	L (mm)	L1 (mm)	L2 (mm)			
64762	TT-7			140	40		15		-
64763	TT-8	2,5		160	60	100	19	10	•
64764	TT-9	3,0	16						
64765	TT-10								



ESD

DESTORNILLADOR ACODADO / OFFSET SCREWDRIVER / TOURNEVIS CONTRE COUDÉ / WINKELSCHRAUBENDREHER / CACCIAVITE A SQUADRA / CHAVE DE PARAFUSOS ANGULAR / КОЛЕНЧАТАЯ ОТВЕРТКА

COD.	A	B	L (mm)	H (mm)			
57675	PH1	PH2	125	32	45		
57676	PH3	PH4	200	50	200		
57677	PZ1	PZ2	125	32	45		
57678	PZ3	PZ4	200	50	200		
57679	4	4 (90°)	100	25	25	10	•
57680	5,5	5,5 (90°)	125	30	45		
57681	6	6 (90°)					
57682	8	8 (90°)	150	40	100		
57683	10	10 (90°)	175	50	200		

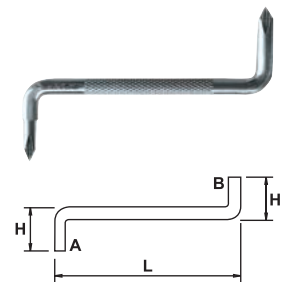

EGA

EXPOSITORES Y SETS / DISPLAYS AND SETS / PRESENTOIRS ET SETS / DISPLAY / ESPOSITORE / DISPLAY STAND / СТЕНДЫ

MASTERTORK

1000V 4 PCS.



COD.	PCS.
74691	4

PCS.	COD.	
1	74665	10 mm
	74667	12 mm
	74669	14 mm
	74670	17 mm



COD.	PCS.	
76675	4	A
76676		B
76677		C

PCS.	COD.	
1	76628	PH0
	76629	PH1
	76630	PH2
	76631	PH3

COD.	PCS.	
76663	4	A
76664		B
76665		C

PCS.	COD.	
1	76633	PZ0
	76634	PZ1
	76635	PZ2
	76636	PZ3

5 PCS.



COD.	PCS.	
69909	5	A
69858		B
68487		C

PCS.	COD.	
1	66422	3 x 100 mm
	66423	4 x 125 mm
	66425	5,5 x 150 mm
	66439	PH1
	66440	PH2

COD.	PCS.	
55506	5	A
55507		B
55508		C

PCS.	COD.	
1	66420	2,5 x 75 mm
	66422	3 x 100 mm
	66423	4 x 125 mm
	66425	5,5 x 150 mm
	66427	8 x 175 mm

COD.	PCS.	
55510	5	B
55511		C

PCS.	COD.	
1	66438	PH0
	66439	PH1
	66440	PH2
	66441	PH3
	66442	PH4

COD.	PCS.	
55513	5	B
55514		C

PCS.	COD.	
1	66456	PZ0
	66457	PZ1
	66458	PZ2
	66459	PZ3
	66460	PZ4

1000V 5 PCS.



COD.	PCS.	
76666	5	A
76667		B
76668		C

PCS.	COD.	
1	76621	3 x 100 mm
	76622	4 x 125 mm
	76624	5,5 x 150 mm
	76625	6,5 x 150 mm
	76626	8 x 175 mm

COD.	PCS.	
76909	5	A
76910		B
76911		C

PCS.	COD.	
1	76621	3 x 100 mm
	76622	4 x 125 mm
	76624	5,5 x 150 mm
	76634	PZ1
	76635	PZ2

COD.	PCS.	
76916	5	B
76917		C

PCS.	COD.	
1	76628	PH0
	76629	PH1
	76630	PH2
	76631	PH3

EGA

6 PCS.



COD.	PCS.	
69910		A
69859	6	B
68488		C

PCS.	COD.	
	66420	2,5 x 75 mm
	66421	3 x 100 mm
1	66423	4 x 125 mm
	66425	5,5 x 150 mm
	66439	PH1
	66440	PH2

COD.	PCS.	
55501		B
55502	6	C

PCS.	COD.	
	66400	3 x 80 mm
	66401	4 x 100 mm
1	66403	5,5 x 125 mm
	66405	6,5 x 150 mm
	66407	8 x 200 mm
	66408	10 x 200 mm

COD.	PCS.	
55518		A
55519	6	B
55520		C

PCS.	COD.	
	66401	4 x 100 mm
	66402	5,5 x 100 mm
1	66404	6,5 x 125 mm
	66457	PZ1
	66458	PZ2
	66459	PZ3

COD.	PCS.	
55521		A
55522	6	B
55523		C

PCS.	COD.	
	66401	4 x 100 mm
	66402	5,5 x 100 mm
1	66405	6,5 x 150 mm
	66439	PH1
	66440	PH2
	66441	PH3

1000V 6 PCS.



COD.	PCS.	
76669		A
76670	6	B
76671		C

PCS.	COD.	
	76620	2,5 x 75 mm
	76621	3 x 100 mm
1	76622	4 x 125 mm
	76624	5,5 x 150 mm
	76625	6,5 x 150 mm
	76626	8 x 175 mm

COD.	PCS.	
76900		A
76901	6	B
76902		C

PCS.	COD.	
	76621	3 x 100 mm
	76622	4 x 125 mm
1	76624	5,5 x 150 mm
	76628	PH0
	76629	PH1
	76630	PH2

COD.	PCS.	
76921		A
76922	6	B
76923		C

PCS.	COD.	
	76620	2,5 x 75 mm
	76621	3 x 100 mm
1	76622	4 x 125 mm
	76623	5,5 x 125 mm
	76629	PH1
	76630	PH2

COD.	PCS.	
76927		A
76928	6	B
76929		C

PCS.	COD.	
	76621	3 x 100 mm
	76622	4 x 125 mm
1	76625	6,5 x 150 mm
	76629	PH1
	76630	PH2
	76631	PH3

COD.	PCS.	
76933		A
76934	6	B
76935		C

PCS.	COD.	
	76621	3 x 100 mm
	76622	4 x 125 mm
1	76625	6,5 x 150 mm
	76633	PZ0
	76634	PZ1
	76635	PZ2

COD.	PCS.	
76930		A
76931	6	B
76932		C

PCS.	COD.	
	76640	T8
	76641	T9
1	76642	T10
	76643	T15
	76644	T20
	76645	T25

COD.	PCS.	
76926	6	C

PCS.	COD.	
	74701	6 mm
	74702	7 mm
1	74703	8 mm
	74704	9 mm
	74705	10 mm
	74708	13 mm

EGA

7 PCS.



COD.	PCS.	
55524		A
55525	7	B
55526		C

PCS.	COD.	
	66474	T6
	66476	T8
	66478	T10
1	66479	T15
	66480	T20
	66481	T25
	66483	T30

COD.	PCS.	
55527		A
55528	7	B
55529		C

PCS.	COD.	
	66478	T10
	66479	T15
	66480	T20
1	66481	T25
	66482	T27
	66483	T30
	66484	T40

1000V 7 PCS.



COD.	PCS.	
76938	7	C

PCS.	COD.	
	74699	5 mm
	74700	5,5 mm
	74701	6 mm
1	74702	7 mm
	74703	8 mm
	74705	10 mm
	74708	13 mm

8 PCS.



COD.	PCS.	
69911		A
69860	8	B
68489		C

PCS.	COD.	
	66421	3 x 100 mm
	66423	4 x 125 mm
	66403	5,5 x 125 mm
1	66405	6,5 x 150 mm
	66438	PH0
	66439	PH1
	66457	PZ1
	66458	PZ2

COD.	PCS.	
55504		B
55505	8	C

PCS.	COD.	
	66400	3 x 80 mm
	66401	4 x 100 mm
	66402	5,5 x 100 mm
1	66403	5,5 x 125 mm
	66404	6,5 x 125 mm
	66406	8 x 150 mm
	66407	8 x 200 mm
	66408	10 x 200 mm

COD.	PCS.	
55515		A
55516	8	B
55517		C

PCS.	COD.	
	66400	3 x 80 mm
	66401	4 x 100 mm
	66403	5,5 x 125 mm
1	66405	6,5 x 150 mm
	66438	PH0
	66439	PH1
	66440	PH2
	66441	PH3

1000V 8 PCS.



COD.	PCS.	
76672		A
76673	8	B
76674		C

PCS.	COD.	
	76621	3 x 100 mm
	76622	4 x 125 mm
	76624	5,5 x 150 mm
1	76625	6,5 x 150 mm
	76629	PH1
	76630	PH2
	76634	PZ1
	76635	PZ2

COD.	PCS.	
76918		A
76919	8	B
76920		C

PCS.	COD.	
	76628	2,5 x 75 mm
	76629	4 x 125 mm
	76630	5,5 x 125 mm
1	76631	6,5 x 150 mm
	76620	PH0
	76622	PH1
	76623	PH2
	76625	PH3

COD.	PCS.	
76939		A
76940	8	B
76941		C

EGA

PCS.	COD.	
	76620	2,5 x 75 mm
	76621	3 x 100 mm
	76622	4 x 125 mm
1	76625	6,5 x 150 mm
	76628	PH0
	76629	PH1
	76630	PH2
	76631	PH3

COD.	PCS.	
76906		A
76907	8	B
76908		C

PCS.	COD.	
	76620	2,5 x 75 mm
	76621	3 x 100 mm
	76622	4 x 125 mm
1	76624	5,5 x 150 mm
	76625	6,5 x 150 mm
	76633	PZ0
	76634	PZ1
	76635	PZ2

COD.	PCS.	
76903		A
76904	8	B
76905		C

PCS.	COD.	
	76621	3 x 100 mm
	76622	4 x 125 mm
	76624	5,5 x 150 mm
1	76625	6,5 x 150 mm
	76629	PH1
	76630	PH2
	76634	PZ1
	76635	PZ2

COD.	PCS.	
76912		A
76913	8	B
76914		C

PCS.	COD.	
	76628	PH0
	76629	PH1
	76630	PH2
1	76631	PH3
	76633	PZ0
	76634	PZ1
	76635	PZ2
	76636	PZ3

9 PCS.



COD.	PCS.	
55992	9	D

PCS.	COD.	
	55330	1/8" x 3"
	55331	5/32" x 4"
	55332	7/32" x 4"
	55334	1/4" x 5"
1	55336	5/16" x 6"
	55338	3/8" x 8"
	55339	25/64" x 8"
	55340	15/32" x 10"
	55341	1/2" x 10"

COD.	PCS.	
56029	9	D

PCS.	COD.	
	55373	5/32"
	55374	3/16"
	55375	7/32"
	55376	1/4"
1	55378	5/16"
	55379	11/32"
	55380	25/64"
	55382	15/32"
	55383	1/2"

10 PCS.



COD.	PCS.	
55991	10	D

PCS.	COD.	
	66400	3 x 80 mm
	66401	4 x 100 mm
	66402	5,5 x 100 mm
	66404	6,5 x 125 mm
1	66406	8 x 150 mm
	66407	8 x 200 mm
	66408	10 x 200 mm
	66409	12 x 250 mm
	66449	13 x 250 mm
	66410	14 x 250 mm

1000V 10 PCS.



COD.	PCS.	
79468	10	D

PCS.	COD.	
	75132	5/32"
	74984	3/16"
	75133	7/32"
	74985	1/4"
1	74986	5/16"
	74987	3/8"
	75136	25/64"
	74988	7/16"
	75138	15/32"
	74989	1/2"

12 PCS.



COD.	PCS.	
55996	12	D

PCS.	COD.	
	66488	TT7
	66489	TT8
	66490	TT9
	66491	TT10
	66492	TT15
1	66493	TT20
	66494	TT25
	66495	TT27
	66496	TT30
	66497	TT40
	66498	TT45
	66499	TT50

EGA

COD.	PCS.	
55997	12	D

PCS.	COD.	
	66510	4 mm
	66511	5 mm
	66512	5,5 mm
	66513	6 mm
	66514	7 mm
1	66515	8 mm
	66516	9 mm
	66517	10 mm
	66518	11 mm
	66519	12 mm
	66520	13 mm
	66521	14 mm

13 PCS.



COD.	PCS.	
56028	13	D

PCS.	COD.	
	66474	T6
	66475	T7
	66476	T8
	66477	T9
	66478	T10
	66479	T15
1	66480	T20
	66481	T25
	66482	T27
	66483	T30
	66484	T40
	66485	T45
	66486	T50

1000V 12 PCS.



COD.	PCS.	
79466	12	D

PCS.	COD.	
	75038	TT7
	75039	TT8
	75040	TT9
	75041	TT10
	75042	TT15
	75043	TT20
1	75044	TT25
	75045	TT27
	75046	TT30
	75047	TT40
	75048	TT45
	75049	TT50

COD.	PCS.	
79467	12	D

PCS.	COD.	
	74698	4 mm
	74699	5 mm
	74700	5,5 mm
	74701	6 mm
	74702	7 mm
1	74703	8 mm
	74704	9 mm
	74705	10 mm
	74706	11 mm
	74707	12 mm
	74708	13 mm
	74709	14 mm

1000V 13 PCS.



COD.	PCS.	
79465	13	D

PCS.	COD.	
	76638	T6
	76639	T7
	76640	T8
	76641	T9
	76642	T10
	76643	T15
1	76644	T20
	76645	T25
	76646	T27
	76647	T30
	76648	T40
	76649	T45
	76650	T50

150 PCS.



COD.	PCS.
66540	150

PCS.	COD.	
	66402	5,5 x 100 mm
	66404	6,5 x 125 mm
	66406	8 x 150 mm
	66421	3 x 60 mm
	66422	3 x 100 mm
	66423	4 x 125 mm
	66425	5,5 x 150 mm
10	66426	6,5 x 150 mm
	76621	3 x 100 mm
	66438	PH0
	66439	PH1
	66440	PH2
	66456	PZ0
	66457	PZ1
	66458	PZ2

56 PCS.



COD.	PCS.
66541	56

PCS.	COD.	
6	66402	5,5 x 100 mm
	66404	6,5 x 125 mm
5	66406	8 x 150 mm
	66423	4 x 125 mm
	66425	5,5 x 150 mm
6	76622	4 x 125 mm
	66439	PH1
5	66440	PH2
6	66457	PZ1
5	66458	PZ2

05

**DESTORNILLADORES
SCREWDRIVERS
TOURNEVIS
SCHRAUBENZIEHER
CACCIAVITI
CHAVES DE FENDA
OTBEPTKH**



EGA

T - MASTERTORK

7 PCS.



COD.	PCS.
55403	7

PCS.	COD.	
1	66571	2,5 mm
	66572	3 mm
	66573	4 mm
	66574	5 mm
	66575	6 mm
	66576	8 mm
	66577	10 mm

5 PCS.



COD.	PCS.	
69912	5	A
66995		B
68495		C

PCS.	COD.	
1	66877	5,5 x 125 mm
	66887	3 x 100 mm
	66890	5 x 150 mm
	66898	PH1
	66899	PH2

COD.	PCS.	
69109	5	A
69125		B
69126		C

PCS.	COD.	
1	66874	3 x 80 mm
	66875	4 x 100 mm
	66877	5,5 x 125 mm
	66879	6,5 x 150 mm
	66881	8 x 200 mm

COD.	PCS.	
69142	5	A
69143		B
69144		C

PCS.	COD.	
1	66886	3 x 60 mm
	66887	3 x 100 mm
	66888	4 x 125 mm
	66890	5 x 150 mm
	66891	5 x 200 mm

COD.	PCS.	
69714	5	B
69718		C

PCS.	COD.	
1	66897	PH0
	66898	PH1
	66899	PH2
	66900	PH3
	67131	PH4

COD.	PCS.	
69723	5	B
69727		C

PCS.	COD.	
1	66907	PZ0
	66908	PZ1
	66909	PZ2
	66910	PZ3
	67064	PZ4

COD.	PCS.	
55536	5	A
55537		B
55538		C

PCS.	COD.	
1	67149	2,5 x 60 mm
	66887	3 x 100 mm
	66888	4 x 125 mm
	66890	5 x 150 mm
	67108	8 x 175 mm

COD.	PCS.	
55543	5	B
55544		C

PCS.	COD.	
1	66897	PH0
	66898	PH1
	66899	PH2
	66900	PH3
	67131	PH4

COD.	PCS.	
55546	5	B
55547		C

PCS.	COD.	
1	66907	PZ0
	66908	PZ1
	66909	PZ2
	66910	PZ3
	67064	PZ4

1000V 5 PCS.



COD.	PCS.	
76961	5	B
76962		C

ROTORK

1000V 4 PCS.



COD.	PCS.	
76987	4	A
76988		B
76989		C

PCS.	COD.	
1	76655	PH0
	76656	PH1
	76657	PH2
	76658	PH3

COD.	PCS.	
76984	4	A
76985		B
76986		C

PCS.	COD.	
1	76659	PZ0
	76660	PZ1
	76661	PZ2
	76662	PZ3

EGA

PCS.	COD.	
1	76655	PH0
	76656	PH1
	76657	PH2
	76658	PH3
	76735	PH4

6 PCS.



COD.	PCS.	
69913	6	A
66996		B
68496		C

PCS.	COD.	
1	67149	2,5 x 60 mm
	66887	3 x 100 mm
	66888	4 x 125 mm
	66890	5 x 150 mm
	66898	PH1
	66899	PH2

COD.	PCS.	
55530	6	A
55531		B
55532		C

PCS.	COD.	
1	66874	3 x 80 mm
	66875	4 x 100 mm
	66877	5,5 x 125 mm
	66879	6,5 x 150 mm
	66881	8 x 200 mm
	66882	10 x 200 mm

COD.	PCS.	
55551	6	A
55552		B
55553		C

PCS.	COD.	
1	66875	4 x 100 mm
	66877	5,5 x 125 mm
	66879	6,5 x 150 mm
	66898	PH1
	66899	PH2
	66900	PH3

COD.	PCS.	
55548	6	A
55549		B
55550		C

PCS.	COD.	
1	66875	4 x 100 mm
	66876	5,5 x 100 mm
	66878	6,5 x 125 mm
	66908	PZ1
	66909	PZ2
	66910	PZ3

1000V 6 PCS.



COD.	PCS.	
76680	6	A
76681		B
76682		C

PCS.	COD.	
1	76651	3 x 100 mm
	76652	4 x 125 mm
	76653	5,5 x 150 mm
	76655	PH0
	76656	PH1
	76657	PH2

COD.	PCS.	
76972	6	A
76973		B
76974		C

PCS.	COD.	
1	76730	2,5 x 60 mm
	76651	3 x 100 mm
	76652	4 x 125 mm
	76653	5,5 x 150 mm
	76654	6,5 x 150 mm
	76732	8 x 175 mm

COD.	PCS.	
76954	6	A
76955		B
76956		C

PCS.	COD.	
1	76651	3 x 100 mm
	76652	4 x 125 mm
	76653	5,5 x 150 mm
	76654	6,5 x 150 mm
	76732	8 x 175 mm
	76733	10 x 200 mm

COD.	PCS.	
76966	6	A
76967		B
76968		C

PCS.	COD.	
1	76730	2,5 x 60 mm
	76651	3 x 100 mm
	76652	4 x 125 mm
	76653	5,5 x 150 mm
	76656	PH1
	76657	PH2

COD.	PCS.	
76942	6	A
76943		B
76944		C

PCS.	COD.	
1	76651	3 x 100 mm
	76652	4 x 125 mm
	76653	5,5 x 150 mm
	76655	PH0
	76656	PH1
	76657	PH2

COD.	PCS.	
76951	6	A
76952		B
76953		C

PCS.	COD.	
1	76651	3 x 100 mm
	76652	4 x 125 mm
	76653	5,5 x 150 mm
	76659	PZ0
	76660	PZ1
	76661	PZ2

EGA

COD.	PCS.	
76975		A
76976	6	B
76977		C

PCS.	COD.	
	76651	3 x 100 mm
	76652	4 x 125 mm
1	76654	6,5 x 150 mm
	76656	PH1
	76657	PH2
	76658	PH3

COD.	PCS.	
76969		A
76970	6	B
76971		C

PCS.	COD.	
	76651	3 x 100 mm
	76652	4 x 125 mm
	76654	6,5 x 150 mm
1	76659	PZ0
	76660	PZ1
	76661	PZ2

COD.	PCS.	
55557		A
55558	7	B
55559		C

PCS.	COD.	
	66917	T6
	66919	T8
	66921	T10
1	66922	T15
	66923	T20
	66924	T25
	66926	T30

COD.	PCS.	
69158		A
69159	8	B
69168		C

PCS.	COD.	
	67149	2,5 x 60 mm
	66887	3 x 100 mm
	66888	4 x 125 mm
1	66890	5 x 150 mm
	66891	5 x 200 mm
	66892	6 x 150 mm
	67108	8 x 175 mm
	67109	10 x 200 mm

COD.	PCS.	
55560		A
55561	8	B
55562		C

PCS.	COD.	
	66874	3 x 80 mm
	66875	4 x 100 mm
	66877	5,5 x 125 mm
1	66879	6,5 x 150 mm
	66897	PH0
	66898	PH1
	66899	PH2
	66900	PH3

8 PCS.



COD.	PCS.	
69914		A
66997	8	B
68497		C

PCS.	COD.	
	66887	3 x 100 mm
	66888	4 x 125 mm
	66877	5,5 x 125 mm
1	66879	6,5 x 150 mm
	66897	PH0
	66898	PH1
	66908	PZ1
	66909	PZ2

COD.	PCS.	
69127		A
69128	8	B
69129		C

PCS.	COD.	
	66874	3 x 80 mm
	66875	4 x 100 mm
	66876	5,5 x 100 mm
1	66877	5,5 x 125 mm
	66878	6,5 x 125 mm
	66880	8 x 150 mm
	66881	8 x 200 mm
	66882	10 x 200 mm

1000V 8 PCS.



COD.	PCS.	
76683		A
76684	8	B
76685		C

PCS.	COD.	
	76651	3 x 100 mm
	76652	4 x 125 mm
	76653	5,5 x 150 mm
1	76654	6,5 x 150 mm
	76656	PH1
	76657	PH2
	76660	PZ1
	76661	PZ2

7 PCS.



COD.	PCS.	
55554		A
55555	7	B
55556		C

PCS.	COD.	
	66921	T10
	66922	T15
	66923	T20
1	66924	T25
	66925	T27
	66926	T30
	66927	T40

EGA

COD.	PCS.	
76963		A
76964	8	B
76965		C

PCS.	COD.	
	76730	2,5 x 60 mm
	76652	4 x 125 mm
	76653	5,5 x 150 mm
1	76654	6,5 x 150 mm
	76655	PH0
	76656	PH1
	76657	PH2
	76658	PH3

COD.	PCS.	
76981		A
76982	8	B
76983		C

PCS.	COD.	
	76730	2,5 x 60 mm
	76651	3 x 100 mm
	76652	4 x 125 mm
1	76654	6,5 x 150 mm
	76655	PH0
	76656	PH1
	76657	PH2
	76658	PH3

COD.	PCS.	
76948		A
76949	8	B
76950		C

PCS.	COD.	
	76730	2,5 x 60 mm
	76731	3 x 60 mm
	76652	4 x 125 mm
1	76653	5,5 x 150 mm
	76654	6,5 x 150 mm
	76659	PZ0
	76660	PZ1
	76661	PZ2

COD.	PCS.	
76978		A
76979	8	B
76980		C

PCS.	COD.	
	76651	3 x 100 mm
	76652	4 x 125 mm
	76653	5,5 x 150 mm
1	76654	6,5 x 150 mm
	76655	PH0
	76656	PH1
	76657	PH2
	76658	PH3

COD.	PCS.	
76957		A
76958	8	B
76959		C

PCS.	COD.	
	76655	PH0
	76656	PH1
	76657	PH2
1	76658	PH3
	76659	PZ0
	76660	PZ1
	76661	PZ2
	76662	PZ3

150 PCS.



COD.	PCS.
66992	150

PCS.	COD.	
	66876	5,5 x 100 mm
	66878	6,5 x 125 mm
	66880	8 x 150 mm
	66886	3 x 60 mm
	66887	3 x 100 mm
	66888	4 x 125 mm
	66890	5 x 150 mm
10	66892	6 x 150 mm
	76651	3 x 100 mm
	66897	PH0
	66898	PH1
	66899	PH2
	66907	PZ0
	66908	PZ1
	66909	PZ2

60 PCS.



COD.	PCS.
66993	60

PCS.	COD.	
6	66876	5,5 x 100 mm
	66878	6,5 x 125 mm
5	66880	8 x 150 mm
	66887	3 x 100 mm
7	66888	4 x 125 mm
	66890	5 x 150 mm
	66898	PH1
6	66899	PH2
	66908	PZ1
	66909	PZ2

MICROTRONIC

100 PCS.



COD.	PCS.
66994	100

PCS.	COD.	
	66846	2 x 50 mm
	66847	2 x 75 mm
	66848	3 x 75 mm
	66849	4 x 75 mm
	66850	PH00
	66851	PH0
	66852	PH1
	66853	PZ0
	66854	PZ1
5	66855	T6
	66856	T7
	66857	T8
	66858	T9
	66859	T10
	66860	T15
	66861	T20
	66862	1,5 x 50 mm
	66863	2 x 50 mm
	66864	2,5 x 50 mm
	66865	3 x 60 mm

EGA



COD.	PCS.
66990	100

PCS.	COD.	
5	66846	2 x 50 mm
	66847	2 x 75 mm
	66848	3 x 75 mm
	66849	4 x 75 mm
	66850	PH00
	66851	PH0
	66852	PH1
	66853	PZ0
	66854	PZ1
	66866	TT6
66867	TT7	
66868	TT8	
66869	TT9	
66870	TT10	
66871	TT15	
66872	TT20	
66862	1,5 x 50 mm	
66863	2 x 50 mm	
66864	2,5 x 50 mm	
66865	3 x 60 mm	

6 PCS.



COD.	PCS.
66999	6

PCS.	COD.	
1	66846	2 x 50 mm
	66848	3 x 75 mm
	66850	PH00
	66851	PH0
	66853	PZ0
66854	PZ1	

1000V 7 PCS.



COD.	PCS.
76083	7

PCS.	COD.	
1	75156	1,5 x 40 mm
	75157	1,8 x 60 mm
	75158	2 x 60 mm
	75159	2,5 x 75 mm
	75201	3 x 75 mm
	75202	PH00
	75203	PH0

ESD

8 PCS.



COD.	PCS.
68898	8

BMAT ESD

PCS.	COD.	Descripción / Description / Description	
1	64730	Alicate universal ESD / ESD Combination plier	115 mm
	64736	Alicate corte diagonal ESD / ESD Diagonal cutting plier	-
1	64733	Alicate telefonista ESD / ESD Long nose plier	135 mm
	64742		2 x 60 mm
	64744	Destornilladores ESD / ESD	3 x 60 mm
	64747	Screwdrivers	PH00
	64748		PH0
	64749		PH1

6 PCS.



COD.	PCS.
68899	6

PCS.	COD.	
1	64747	PH00
	64748	PH0
	64742	2 x 60 mm
	64744	3 x 60 mm
	64753	PZ0
	64754	PZ1

ESD

BUSCAPOLOS / VOLTAGE TESTER / TESTEUR / SPANNUNGSPRÜFER / CERCAFASE / BUSCA-POLOS / ИЗМЕРИТЕЛЬ НАПРЯЖЕНИЯ

BUSCAPOLOS / VOLTAGE TESTER / TESTEUR / SPANNUNGSPRÜFER / CERCAFASE / BUSCA-POLOS / ИЗМЕРИТЕЛЬ НАПРЯЖЕНИЯ

COD.	L (mm)		V			
66072	150	3 x 15	100-250 AC	20	12	•
66073	190	3 x 15	100-250 AC	30	12	•



BUSCAPOLOS DIGITAL / DIGITAL VOLTAGE TESTER / TESTEUR DIGITAL / DIGITAL SPANNUNGSPRÜFER / CERCAFASE DIGITALE / BUSCA-POLOS DIGITAL / ЦИФРОВОЙ ИЗМЕРИТЕЛЬ НАПРЯЖЕНИЯ



COD.	L (mm)		V			
66074	160	3 x 15	0-220 AC/DC	40	4	•







CARACTERÍSTICAS / FEATURES / CARACTÉRISTIQUES

5 niveles de tensión / 5 voltage levels / 5 niveaux de tension

EGA
TESTER ELECTRÓNICO MEDIDOR DE TENSIÓN 2 EN 1 / ELECTRONIC TESTER 2 IN 1 / TESTEUR ELECTRONIQUE À MESURE DE TENSION 2 EN 1 / SPANNUNGSPRÜFER ELEKTRONIK, 2 IN 1 / TESTER ELECTRONICO 2 IN 1 / MEDIDOR DE TENSÃO 2 EM 1 / ЭЛЕКТРОННЫЙ ТЕСТЕР 2 В 1

COD.	L (mm)	V			
66075	190	6-380 AC	220	4	•



BUSCAPOLOS CLASSIC / VOLTAGE TESTER / TESTEUR / SPANNUNGSPRÜFER / CERCAFASE / BUSCA-POLOS / ИЗМЕРИТЕЛЬ НАПРЯЖЕНИЯ

COD.	L (mm)			V			
66070	140	65	3	100-250 AC	20		
66071	190	100	4	90-480 AC	35	12	•
66069			3,5		40		

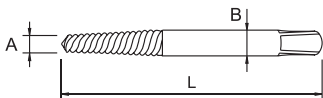

MAGNETIZADOR-DESMAGNETIZADOR / MAGNETIZER-DEMAGNETIZER / MAGNETISEUR-DEMAGNETISEUR / MAGNETISIERT-ENTMAGNETISIERTVORRICHTUNG / MAGNETIZZATORE- SNAGNETIZZATORE / MAGNETIZADOR-DESMAGNETIZADOR / НАМАГНИЧИВАТЕЛЬ-РАЗМАГНИЧИВАТЕЛЬ

COD.			
69504	80	12	•

EXTRACTORES DE TORNILLOS / SCREW EXTRACTORS / EXTRACTEUR DE VIS / SCHRAUBENAUSDREHER / ESTRATTORI / EXTRACTORES DE PERNOS / РЕЗЬБОВЫЕ ЭКСТРАКТОРЫ

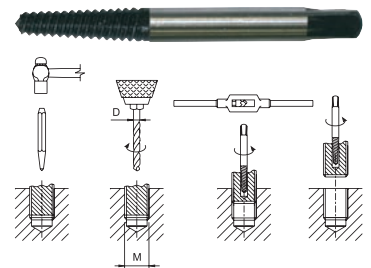
COD.	L (mm)	A (mm)	B (mm)	M	D (mm)	
61583	50	2,6	3,9	3-6	2,5	5
61584	55	3,0	4,3	6-8	3,0	10
61585	65	4,0	6,5	8-11	4,5	20
61586	75	4,5	7,5	11-14	6,0	30
61587	85	7,0	11	14-18	8,0	50
61588	90	9,0	15	18-25	11	100
61589	95	9,5	19	25-35	14	150
61590	100	14	24	>35	20	200

SET

COD.	PCS.	
61591	5	100
61592	6	200
61593	8	750

Composición / Composition / Composition
 61583, 61584, 61585, 61586, 61587, 61588, 61589, 61590

