

2

TOOLKITS



PERSONALICE EL COLOR
CUSTOMIZE THE COLOUR
PERSONNALISEZ LA COULEUR



Personalice el color de sus cajas, carros y mobiliario de taller seleccionando entre 4 colores disponibles, para:

- Potenciar la imagen corporativa de su empresa.
- Diferenciar visualmente los equipamientos por aplicaciones o divisiones.

Todos ellos disponibles en rojo (RAL 2002*), verde (RAL 6032*), azul (RAL 5017*) y amarillo (RAL 1003*).

* Colores aproximados

Customize the colour of your tool boxes, trolleys and workshop equipment by selecting from the 4 available colours:

- Strengthen the corporate image of your company.
- Visually distinguish your equipment by application or division.

All available in red (RAL 2002*), green (RAL 6032*), blue (RAL 5017*) and yellow (RAL 1003*).

* Approximate colors

Vous pouvez personnaliser la couleur de vos caisses, servantes et mobilier d'atelier en sélectionnant entre les 4 couleurs disponibles, afin de:

- Distinguer visuellement les équipements par applications ou divisions.
- Améliorer l'image corporative de votre société.

Sont toutes disponibles en rouge (RAL 2002*), vert (RAL 6032*), bleu (RAL 5017*) et jaune (RAL 1003*).

* Couleurs approximatives

SISTEMAS ANTIVUELCO
ANTI-OVERTURN SYSTEMS
SYSTÈME ANTI-RENVERSEMENT



EGA Master ha ampliado su gama de sistemas ANTIVUELCO dentro de su extensa variedad de armarios-carros de herramientas y cofres.

- 1 El Sistema OODO ("Only One Drawer Open") le permite al usuario abrir un solo cajón cada vez. Las referencias que poseen este sistema son la 51025 y 51039.
- 2 Por otro lado, el resto de referencias llevan incorporado el sistema de seguridad de apertura lateral e individual de cajones ANTIVUELCO.

EGA Master has widened its range of ANTI-OVERTURN systems within its vast variety of roller cabinets and tool chests.

- 1 The OODO System ("Only One Drawer Open") allows the user to open only one drawer each time. The references which have this system are 51025 and 51039.
- 2 All other references are equipped with the ANTI-OVERTURN security system with individual and lateral open button in each tray.

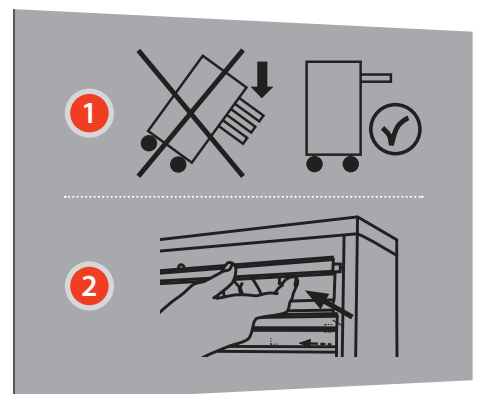

Dans sa grande variété de servantes à roues et coffres, EGA Master a élargi sa gamme de système ANTI-RENVERSEMENT.

- 1 Le système OODO ("Only One Drawer Open") permet à l'utilisateur d'ouvrir un seul tiroir chaque fois. Les références qui possèdent ce système sont : 51025 et 51039.
- 2 D'autre part, le reste des références intègrent le système de sécurité d'ouverture latérale et individuelle des tiroirs ANTI-RENVERSEMENT.

REALIDAD AUMENTADA AUGMENTED REALITY RÉALITÉ AUGMENTÉE

La App EGA Master RA (Realidad Aumentada) permite visualizar virtualmente en su pantalla los distintos elementos de mobiliario EGA Master, a tamaño real, en sus instalaciones.

Simplemente, coloque los **marcadores** en la zona de trabajo donde querría incorporar su mobiliario, enfóquelo con la pantalla de su smartphone o tablet y el elemento aparecerá en pantalla como si realmente estuviera en sus instalaciones. Esto le permitirá decidir la cantidad, tamaño y color de los elementos de mobiliario que mejor se adecuen a sus necesidades e instalaciones.

*The EGA Master AR (Augmented Reality) App allows the user to create an on-screen virtual visualisation incorporating real size elements of EGA Master workshop equipment into their own installations. By simply focusing the screen of your smartphone or tablet at a location within your workplace you can use **markers** to place equipment which will then appear in the on-screen display creating a virtual view of the installation as it would look in real size. This will allow you to make decisions on quantities, size and colour of equipment that best suits your specific needs and facilities.*

L'application EGA Master RA (Réalité Augmentée) permet de visualiser les différents éléments du mobilier EGA Master virtuellement sur l'écran, à taille réelle, dans vos installations. Placez simplement les **marqueurs** dans la zone de travail où vous voudriez incorporer votre mobilier, focalisez-le avec l'écran de votre smartphone ou tablette, et l'élément apparaîtra sur l'écran comme s'il était réellement dans vos installations. Cela vous permettra de décider la quantité, taille et couleur des éléments du mobilier que s'adapte le mieux à vos besoins et installations.



MARCADORES MARKERS MARQUEURS





JUEGOS UNIVERSALES / UNIVERSAL SETS / SETS UNIVERSELS / UNIVERSAL SETS / KIT UNIVERSALE / JOGOS UNIVERSAIS / УНИВЕРСАЛЬНЫЕ НАБОРЫ

■ 1386 PCS.

■ MM / INCH



COD.	PCS.		Medidas en / Sizes in / Mesures en	
56175				330
56176	1386		51074	580
56177			51074 (2), 50950	940



PCS.	Composición / Composition / Composition	Descripción / Description / Description	
4	67202, 67203, 67204, 67205	Palanca cabeza curva / Pry bar	-
29	55266, 55267, 55268, 55269, 55270, 55271, 55272, 55273, 55274, 55275, 55276, 55277, 55278, 55279, 55280, 55281, 55282, 55283, 55284, 55285, 55286, 55287, 55288, 55289, 55290, 55291, 55292, 55293, 55294	Blister de puntas de impacto / Blister of impact bits	5/16", 5 pcs
31	66944	Set de puntas Philips-Pozidriv® / Kit of bits Philips-Pozidriv®	31 pcs
2	66261, 66262	Adaptador portapuntas / Magnetic bit holder	
3	69570, 69572, 69574	Sargentos G / G Clamps	-
7	62847, 62848, 62849, 62850, 62851, 62853, 62856	Cinceles mecánicos / Flat cold chisel	
103	61322, 61311, 63974, 61312, 63975, 61313, 61314, 61315, 61316, 61317, 61318, 61319, 61320, 61321, 63977, 63978, 63979, 63980, 63981, 63982, 63983, 63984, 63985, 63986, 63987, 60420, 60421, 60422, 60423, 60424, 60425, 60426, 60427, 60428, 60429, 60430, 63989, 63990, 63991, 63992, 63993, 63994, 63995, 63996, 63997, 63998, 67640, 67641, 67642, 67643, 67644, 67645, 67646, 67647, 67648, 67649, 67650, 67651, 67652, 67660, 67661, 67662, 67663, 67664, 67665, 67666, 67667, 67668, 67669, 67670, 67674, 67675, 67676, 67677, 67678, 67679, 67680, 67681, 67682, 67683, 67684, 67689, 67690, 67691, 67692, 67693, 67694, 67695, 56015, 56016, 56017, 56018, 56019, 56020, 56021, 56022, 56024, 56025, 56026, 56027	Llave vaso / Socket wrench	
38	66733, 66734, 66735, 66736, 66737, 66738, 66739, 66740, 66741, 66742, 66744, 66745, 66746, 66747, 66748, 66749, 66750, 66751, 66752, 66753, 66754, 66755, 66756, 55697, 55698, 55699, 55700, 55670, 55671, 55672, 55673, 55674, 55675, 55676, 55677, 55678, 55679, 66743	Punta atornilladora con vaso / Socket bit	1/4"
	65880	Adaptador para llaves de vaso / Adapter for socket wrenches	
	66732	Destornillador portavasos / Socket holder	
1	62603	Llave de carraca reversible / Reversible ratchet handle	
	61438	Mango corredizo / Sliding -F- handle	
	61435	Articulación universal / Universal joint	
4	61442, 61454, 61443, 61444	Alargadera / Extension	
1	61445	Alargadera flexible / Flexible handle	1/4"
	65874	Mango flexible / Flexible handle	
56	67541, 67542, 67543, 67544, 67545, 67546, 67547, 67548, 67549, 67550, 67551, 67552, 67553, 67554, 67555, 67556, 67557, 67558, 67559, 67620, 67621, 67622, 67623, 67624, 67625, 67626, 67627, 67725, 67726, 67727, 67728, 67729, 67730, 67731, 67732, 67733, 67734, 67735, 67736, 67737, 67738, 67739, 67740, 67750, 67751, 67752, 67753, 67754, 67755, 67756, 67757, 67758, 67759, 67760, 67761, 67762	Llave de vaso / Socket wrench	
48	66760, 66761, 66762, 66763, 66764, 66765, 66766, 66767, 66768, 66769, 66770, 66771, 66772, 66773, 66774, 66775, 66776, 66777, 66778, 66779, 66780, 66781, 66782, 66783, 66784, 66785, 66786, 66787, 66788, 66789, 66790, 66791, 66792, 66793, 66794, 66795, 66796, 55701, 55702, 55703, 55680, 55681, 55682, 55683, 55684, 55685, 55686, 55687	Punta atornilladora con vaso / Socket bit	
2	65884, 65881	Adaptador para llaves de vaso / Adapter for socket wrenches	
	61460, 61461	Llave de vaso para bujías	3/8"
22	55710, 55711, 55712, 55713, 55714, 55715, 55716, 55717, 55718, 55719, 55720, 55721, 55724, 55725, 55726, 55727, 55728, 55729, 55730, 55731, 55732, 55733	Llave fija Crow Foot / Open end Crow Foot wrench	
20	55736, 55737, 55738, 55739, 55740, 55741, 55742, 55743, 55744, 55745, 55746, 55750, 55751, 55752, 55753, 55754, 55755, 55756, 55757, 55758	Llave fija hexagonal Crow Foot / Hexagonal Crow Foot wrench	
	62604	Llave de carraca reversible / Reversible ratchet handle	
1	61439	Mango corredizo en T / Sliding T handle	
	61436	Articulación universal / Universal joint	
2	61447, 61450	Alargadera / Extension	
1	61409	Berbiquí / Speeder handle	
	65875	Mango articulado / Hinged handle	
94	61800, 61801, 61802, 61803, 61804, 61805, 61806, 61807, 61808, 61809, 61810, 61811, 61812, 61813, 61814, 61815, 61816, 61817, 61818, 61819, 61820, 61821, 61822, 61823, 60460, 60461, 60462, 60463, 60464, 60465, 60466, 60459, 60467, 60468, 60469, 60470, 60471, 60472, 60473, 60474, 60475, 60476, 60477, 60478, 67780, 67781, 67782, 67783, 67784, 67785, 67786, 67787, 67788, 67789, 67791, 67792, 67793, 67794, 67795, 67796, 67797, 67798, 67799, 67800, 67805, 67806, 67807, 67808, 67809, 67810, 67811, 67812, 67813, 67814, 67815, 67816, 67817, 67818, 55795, 55796, 55797, 55798, 55799, 55800, 55801, 55802, 55803, 55804, 55805, 55806, 55807, 55808, 55809, 55810	Llave de vaso / Socket wrench	
62	66801, 66802, 66803, 66804, 66805, 66806, 66807, 66808, 66809, 66810, 66811, 66812, 66813, 66814, 66815, 66816, 66817, 66818, 66819, 66820, 66821, 66822, 66823, 66824, 66825, 66826, 66827, 66828, 66829, 66830, 66831, 66832, 66833, 66834, 66835, 66836, 66837, 66838, 66839, 66840, 66841, 55705, 55706, 55707, 55688, 55689, 55690, 55691, 55692, 55693, 55695, 55696, 66842, 65985, 65986, 65987, 65988, 65989, 65990, 65991, 65992, 65993	Punta atornilladora con vaso / Socket bit	1/2"
2	65885, 65882	Adaptador para llaves de vaso / Adapter for socket wrenches	
	61462, 61463	Llave de vaso para bujías	
3	61441, 61483, 61484	Mango articulado / Hinged handle	
	61453, 61455, 61458	Alargadera / Extension	
1	61434	Berbiquí / Speeder handle	
	62606	Llave de carraca reversible / Reversible ratchet handle	

PCS.	Composición / Composition / Composition	Descripción / Description / Description	
1	61440	Mango corredizo en T / Sliding T handle	
	61437	Articulación universal / Universal joint	
63	60658, 60603, 60604, 60605, 60606, 60607, 60608, 60609, 60610, 60611, 60612, 60639, 60613, 60614, 60615, 60616, 60617, 60618, 60619, 65213, 65214, 65215, 65216, 65217, 65218, 65219, 65220, 65221, 65222, 65223, 65224, 65225, 65226, 60660, 60661, 60662, 60663, 60664, 60665, 60666, 60667, 60668, 60669, 60670, 60671, 60672, 60673, 60674, 60675, 60676, 56350, 56351, 56352, 56353, 56354, 56355, 56356, 56357, 56358, 56359, 56360, 56361, 56362	Llave de vaso de impacto / Impact socket wrench	1/2"
18	65936, 65937, 65938, 65939, 65940, 65941, 65942, 65943, 65944, 65945, 65946, 65947, 65948, 65949, 65950, 65951, 65952, 65953	Puntas atornilladoras de impacto con vaso / Impact socket bit	
2	60698, 60699	Adaptador (vasos de impacto) / Adapter (impact socket wrench)	
1	60705	Articulación universal (vasos de impacto) / Universal joint (impact socket wrench)	
	60711	Alargadera (vasos de impacto) / Extension (impact socket wrench)	
79	60501, 60502, 60503, 60504, 60505, 60506, 60507, 60508, 60509, 60510, 60511, 60512, 60513, 60514, 60515, 60516, 60517, 60518, 60519, 60520, 60521, 60522, 60523, 60524, 67565, 67566, 67567, 67568, 67569, 67570, 67571, 67572, 67573, 67574, 67575, 67576, 67577, 67578, 67579, 67580, 67581, 67582, 67583, 67584, 67585, 67586, 67587, 67588, 67595, 67596, 67597, 67598, 67599, 67601, 67602, 67603, 67604, 67605, 67607, 67608, 67610, 67612, 60526, 60527, 60528, 60529, 60530, 60531, 60500, 60532, 60533, 60534, 60535, 60536, 60537, 60538, 60539, 60540, 60541	Llave de vaso / Socket wrench	
2	65883, 65886	Adaptador para llaves de vaso / Adapter for socket wrenches	
1	61859	Llave de carraca reversible / Reversible ratchet handle	
2	61473, 61456	Mango articulado / Hinged handle	
1	61864	Mango corredizo en T / Sliding T handle	
	61860	Articulación universal / Universal joint	3/4"
2	61865, 61866	Alargadera / Extension	
80	63879, 60620, 60621, 60622, 60623, 60624, 60625, 60626, 60627, 60628, 60629, 60630, 60631, 60632, 60633, 60634, 60635, 60636, 60637, 63880, 60638, 63881, 65227, 65228, 65229, 65230, 65231, 65232, 65233, 65234, 65235, 65236, 65237, 65238, 65239, 68689, 65240, 65241, 65242, 65243, 65244, 68688, 60679, 60680, 60681, 60682, 60683, 60684, 60685, 60686, 60687, 60688, 60689, 60690, 60691, 63895, 63896, 63897, 65245, 65246, 65247, 65248, 65249, 65250, 65251, 65252, 56363, 56364, 56365, 56366, 56367, 56368, 56369, 56370, 56371, 56372, 56373, 56374, 56375, 56376	Llave de vaso de impacto / Impact socket wrench	
2	60700, 60701	Adaptador (vasos de impacto) / Adapter (impact socket wrench)	
1	60706	Articulación universal (vasos de impacto) / Universal joint (impact socket wrench)	
	60714	Alargadera (vasos de impacto) / Extension (impact socket wrench)	
8	61593	Set de extractores de tornillos / Set of screw extractors	8 pcs
2	65555, 65570	Galgas de espesores / Feeler gauge	
6	63498, 63534, 63570, 63606, 63642, 63678	Limas / Files	
1	58641	Linterna táctil / Tactile flashlight	
2	63742, 63299	Arcos de sierra / Hack saws	
7	69612, 69614, 69617, 69750, 69748, 69722, 69752	Martillos / Hammers	
5	61110, 61111, 61112, 61113, 61114	Llave ajustable / Adjustable wrench	
4	60795, 60796, 60797, 60798	Llave media luna / Half moon spanner	
10	60785, 60786, 60787, 60788, 60789, 60790, 60791, 60792, 60793, 60794	Llave para racores / Flare nut	
71	63965, 63966, 67880, 63967, 67881, 61725, 61726, 61727, 61728, 61729, 61730, 61731, 61732, 61733, 61734, 61735, 61736, 61737, 61738, 61739, 61740, 61741, 61742, 61743, 61744, 61745, 61746, 61747, 61748, 61749, 61750, 60951, 60952, 60953, 60954, 60955, 60956, 67882, 67883, 67953, 67954, 61653, 60340, 60341, 67878, 60342, 60343, 60344, 60345, 60346, 60347, 60348, 60349, 60350, 60351, 60352, 60353, 60354, 60355, 60356, 60357, 60358, 60957, 60958, 60961, 60959, 60962, 60897, 60898, 60899, 60960	Llave combinada	mm/inch
26	67963, 67967, 61601, 61602, 61603, 61604, 61605, 61606, 61607, 61608, 61609, 61610, 61611, 61612, 61613, 60300, 60302, 60303, 60305, 67943, 60308, 60310, 60311, 60312, 60314, 67946	Llave fija / Open-end wrench	
32	61774, 61775, 61776, 61777, 61778, 61779, 61780, 61781, 61782, 61783, 61784, 61785, 61786, 61787, 67862, 67863, 61790, 60380, 60381, 60382, 60383, 60384, 60385, 60386, 60387, 60388, 60389, 60390, 60391, 60392, 60393, 60394	Llave acodada / Double offset ring wrench	
16	68283, 68284, 68285, 68286, 68287, 68288, 68289, 68290, 68291, 68292, 68293, 68295, 68296, 68297, 68298, 68299	Llave de gancho / Adjustable hook wrench	
11	65089, 65090, 65091, 65092, 65093, 65095, 65096, 65098, 65099, 65100, 65102	Llave de carraca para racores / Ratcheting ring wrench	
9	61301, 61302, 61303, 61304, 61305, 61306, 61308, 61309, 61310	Llave vaso doble articulación / Double ended swivel wrench	
20	61495, 61496	Juego de llaves Allen bola / Set of hexagonal key wrenches ball type	10 pcs, mm/inch
9	56566	Juego de llaves Tamper Torx / Set of Tamper Torx keys	9 pcs
12	63280, 63281, 63282, 63283, 63284, 63285, 63286, 63288, 63289, 63290, 63291, 63292	Llave de carraca doble Mastergear / Mastergear double ratchet wrench	
20	62710, 62711, 62712, 62713, 62714, 62715, 62716, 62717, 62718, 62719, 62720, 62721, 62722, 62723, 62724, 62725, 62726, 62727, 62728, 62729	Llave combinada Stubby Mastergear	mm/inch
2	63199, 63205	Cortatubos para plástico / Plastic pipe cutter	
3	61015, 61017, 61018	Llave Heavy Duty / Heavy Duty pipe wrench	
2	61405, 61406	Llave Mastergrip / Mastergrip wrench	

PCS.	Composición / Composition / Composition	Descripción / Description / Description	
2	62965, 62968	Llaves dinámicas / Torque wrenches	-
1	66873	Destornillador dinámico / Torque screwdriver	1/4"
19	66400, 66401, 66403, 66405, 66407, 66448, 66408, 66409, 66449, 66410, 55330, 55331, 55333, 55335, 55337, 55338, 55339, 55340, 55341	Destornilladores mecánicos / Slotted screwdrivers	mm/inch
14	76620, 76621, 76622, 76624, 76625, 76626, 76627, 75063, 75064, 75065, 75067, 75068, 75069, 75081	Destornilladores electricidad / Electrician screwdrivers	1000V, mm/inch
5	66438, 66437, 66443, 66441, 66442 66456, 66472, 66473, 66459, 66460	Destornillador Philips / Philips screwdriver Destornillador Pozidriv® / Screwdriver Pozidriv®	
3	63954, 63955, 63956	Alicates de bocas semi-redondas y extralargos / Extra-long reach halfround nose pliers	-
9	62241, 62242, 62243, 62244, 62245, 62246, 62247, 62248, 62249	Alicates mini / Mini Pliers	
12	66488, 66489, 66490, 66491, 66492, 66493, 66494, 66495, 66496, 66497, 66498, 66499	Destornilladores Tamper Torx / Screwdrivers Tamper Torx	
11	66501, 66502, 66503, 66504, 66505, 66506, 66507, 55364, 55365, 55368, 55369	Destornilladores punta esfera / Ball point screwdrivers	mm/inch
3	66530, 66531, 66532	Destornilladores Robertson / Screwdrivers Robertson	
6	66525, 55371, 67192, 66526, 67193, 66527	Destornilladores carroceros / Stubby screwdrivers	
17	62331, 62332, 62333, 62337, 62338, 62339, 62340, 62341, 62342, 62343, 62540, 62344, 62370, 62345, 62346, 62348, 62349	Alicates / Pliers	
20	62214, 62215, 62183, 62216, 62217, 62218, 62219, 62182, 62220, 62221, 62222, 62223, 62181, 62224, 62225, 62226, 62227, 62180, 62228, 62229	Alicates Circlips / Circlips pliers	
3	63950, 63951, 63952	Alicates de corte al ras / Flush cutting pliers	
1	61035	Llave de cadena reversible / Reversible chain pipe wrench	
	63371	Escariador manual / Manual reamer	
2	68001, 68003	Abocinador puente / Flaring tool	
1	69501	Cortador de metal / Metallic cutter	
2	65708, 65723	Flexómetros Platinum / Platinum Measuring tapes	
	65480	Calibre pie de rey / Vernier Caliper	-
1	65588	Recogedor articulado telescópico / Telescopic joint pick up	
	55836	Llave de impacto neumática / Pneumatic impact wrench	
	63915	Cortabridas / Plastic tie cutter	
14	63394, 63395, 63396, 63397, 63398, 63399, 63400, 63415, 63416, 63417, 63418, 63419, 63420, 63421,	Botadores / Punches	
6	63435, 63436, 63437, 63438, 63439, 63440,	Granetes / Center punches	
2	62097, 62174	Tenazas Grip / Grip pincers	
	62624, 62625	Alicate trenzador de alambre / Wire twist plier	
1	62128	Tenaza canal / Box joint plier	
29	61870, 61871, 61872, 61873, 61874, 61875, 61876, 61877, 61878, 61879, 61880, 61881, 61882, 61883, 61884, 61885, 61886, 61887, 61888, 61889, 61890, 61891, 61892, 61893, 61894, 61895, 61768, 61772, 61770	Llaves de pipa / Angled sockets	
26	61530, 61531, 61532, 61533, 61534, 61535, 61536, 61537, 61538, 61539, 61540, 61541, 61542, 61543, 61544, 61545, 61546, 61547, 61548, 61549, 61550, 61551, 61552, 61553, 61554, 61555	Llave combinada articulada Mastergear	mm/inch
3	62090, 62091, 62092	Alicate tipo Ford / Slip joint plier	
	62123, 62124, 62125	Tenaza rusa / Tower pincer	
1	66072	Buscapolos / Voltage tester	
3	62169, 62170, 62171	Tijeras articuladas / Aviation tin snips	-
10	64670	Juego de sacabocados / Hollow punch set	
1	65159	Nivel torpedo / Torpedo spirit level	
18	56200, 56201, 56202, 56203, 56204, 56205, 56206, 56207, 56208, 56209, 56210, 56211, 56212, 56213, 56214, 56215, 56216, 56217,	Llaves fijas extrafinas / Slim open end wrenches	mm/inch
27	66846, 66847, 66848, 66849, 55449, 55450, 55451, 55452, 66850, 66851, 66852, 66853, 66854, 66866, 66867, 66868, 66869, 66870, 66871, 66872, 66862, 66863, 66864, 66865, 55454, 55455, 55457	Destornilladores Microtronic / Screwdrivers Microtronic	
5	56230, 56231, 56232, 56233, 56234 56235, 56236, 56237, 56238, 56239	Llaves estrella dos bocas extrafina compensada a 15° / Slim double ring wrenches 15° bent Llaves estrella plana de dos bocas extrafinas / Slim flat double ring wrenches	

■ 633 PCS.
■ MM / INCH





COD.	PCS.		Medidas en / Sizes in / Mesures en		
68960					170
68961	633		50950	mm/inch	265
55765			51074 (2)		682

PCS.	Composición / Composition / Composition	Descripción / Description / Description	
20	62214, 62215, 62216, 62217, 62218, 62219, 62220, 62221, 62222, 62223, 62224, 62225, 62226, 62227, 62228, 62229, 62180, 62181, 62182, 62183	Alicates Circlips / Circlips pliers	
9	66400, 66401, 66403, 66405, 66407, 66408, 66409, 66410, 66525	Destornilladores mecánicos / Slotted screwdrivers	
7	76620, 76621, 76622, 76624, 76625, 76626, 76627	Destornilladores electricistas / Electrician screwdrivers	
6	66438, 66439, 66440, 66441, 66442, 66526 66456, 66457, 66458, 66459, 66460, 66527	Destornilladores Philips / Philips screwdriver	
13	66474, 66475, 66476, 66477, 66478, 66479, 66480, 66481, 66482, 66483, 66484, 66485, 66486	Destornilladores Pozidriv® / Pozidriv® screwdrivers	
7	66571, 66572, 66573, 66574, 66575, 66576, 66577	Destornilladores Torx® / Torx® screwdrivers	
16	69870	Destornilladores T-Mastertork / T-Mastertork screwdrivers	
13	61824, 61825, 61826, 61827, 61828, 61829, 61830, 61831, 61832, 61833, 61834, 61835, 61836	Set reversible Mastergear / Set rev. Mastergear	
18	61840, 61841, 61842, 61843, 61844, 61845, 61846, 61847, 61848, 61849, 61850, 61851, 61852, 61853, 61854, 61855, 61856, 61858	Llaves de tubo doble boca / Socket double ended wrench	
32	61725, 61726, 61727, 61728, 61729, 61730, 61731, 61732, 61733, 61734, 61735, 61736, 61737, 61738, 61739, 61740, 61741, 61742, 61743, 61744, 61745, 61746, 61747, 61748, 61749, 61750, 60951, 60952, 60953, 60954, 60955, 60956	Llaves articuladas en T / T-handle wrenches with universal joint	
23	60340, 60341, 60342, 60343, 60344, 60345, 60346, 60347, 60348, 60349, 60350, 60351, 60352, 60353, 60354, 60355, 60356, 60357, 60358, 60957, 60958, 60959, 60960	Llaves combinadas / Combination wrenches	mm inch
14	61700, 61701, 61702, 61703, 61704, 61705, 61706, 61707, 61708, 61709, 61710, 61711, 61712, 61713	Llaves fijas / Open-end wrenches	mm inch
15	60300, 60301, 60302, 60303, 60304, 60305, 60306, 60307, 60308, 60309, 60310, 60311, 60312, 60313, 60314	Llaves acodadas / Double offset ring wrenches	mm inch
16	61775, 61776, 61777, 61778, 61779, 61780, 61781, 61782, 61783, 61784, 61785, 61786, 61787, 61788, 61789, 61790	Juego / Set	1/2", mm, 25 pcs 1/2", inch, 25 pcs
15	60380, 60381, 60382, 60383, 60384, 60385, 60386, 60387, 60388, 60389, 60390, 60391, 60392, 60393, 60394	Llaves de pipa / Angled sockets	-
25	61960 61963	Llaves hexagonales / Hexagonal keys	mm inch
26	61870, 61871, 61872, 61873, 61874, 61875, 61876, 61877, 61878, 61879, 61880, 61881, 61882, 61883, 61884, 61885, 61886, 61887, 61888, 61889, 61890, 61891, 61892, 61893, 61894, 61895	Botadores octogonales / Octagonal punches	
23	65302, 65303, 65304, 65305, 65306, 65307, 65308, 65309, 65310, 65311, 65312, 65313, 65314, 61501, 61502, 61503, 61504, 61505, 61506, 61507, 61508, 61509, 61510	Granetes hexagonales / Hexagonal center punches	
15	65315, 65316, 65317, 65318, 65319, 65320, 65321, 65322, 65323, 65324, 65325, 65326, 65327, 65328, 65329	Cortafrios / Chisel	
7	63401, 63402, 63403, 63404, 63405, 63406, 63407	Alicates / Pliers	
6	63435, 63436, 63437, 63438, 63439, 63440	Alicates mini / Mini Pliers	
3	63178, 63179, 63180	Tenazas de canal / Box joint pliers	
13	62331, 62332, 62333, 62337, 62338, 62339, 62340, 62341, 62342, 62343, 62344, 62345, 62349	Llave ajustable / Adjustable wrench	
9	62241, 62242, 62243, 62244, 62245, 62246, 62247, 62248, 62249	Extractores / Gear pullers	
3	62133, 62134, 62135	Arco de sierra / Hack Saw	
2	61112, 61114	Juego vasos / Socket set	1/4", mm 1/4", inch
5	62586, 62587, 62588, 62589, 62590	Llave dinamoétrica reversible / Reversible torque wrench	1/2", 40-200 nm
1	63748	Martillos / Hammers	
29	61958 61961	Juego puntas / Bits set	-
1	62963	Llave HD / HD Pipe wrench	12"
7	69614, 69619, 69622, 69750, 69742, 69729, 69521	Tenazas Grip / Grip pliers	
33	66942	Limas / Files	
2	61016, 61018	Tijera de chapa / Tin snip	
8	62177, 62178, 62172, 62231, 62486, 62487, 62508, 62490,	Tijera electricista / Electrician's scissors	
6	63498, 63534, 63570, 63606, 63642, 63678	Calibre / Caliper	
1	62233 69534	Sargentos G / G Clamps	
1	65479	Sargentos F / F Clamps	
3	69570, 69572, 69575 69582, 69586, 69588	Nivel trapezoidal profesional / Professional bridge type spirit level	400 mm
1	65155 66731	Destornillador portapuntas magnético / Screwdriver magnetic bitholder	
10	60693	Juego de vasos impacto / Impact socket sets	mm inch
11	61267	Tenaza rusa / Tower pincer	9", 10"
2	62123, 62124 62438, 62440	Tenaza carpintero / Carpenter pincer	
4	69529	Set 4 pinzas / Set 4 tweezers	
1	62493	Alicate de terminales / Crimping pliers	
11	65089, 65090, 65091, 65092, 65093, 65095, 65096, 65098, 65099, 65100, 65102	Llaves de carcaca para racores	
19	66846, 66848, 66849, 66850, 66851, 66852, 66853, 66854, 66855, 66856, 66857, 66858, 66859, 66860, 66861, 66862, 66863, 66864, 66865	Juego destornilladores Microtronic / Microtronic screwdriver set	
1	69504 65362	Magnetizador-desmagnetizador / Magnetizer-demagnetizer	
6	63714, 63715, 63716, 63717, 63718, 63719	Flexómetros / Measuring tape	3m/10'
	65595	Limas de aguja / Needle files	
	65586	Recogedor telescópico / Telescopic joining pick up	
	65774	Espejo articulado / Joint telescopic mirror	
1	63119	Regla / Ruler	300 mm
	63376	Cortatubos cobre / Copper tube cutter	42 mm
	63207	Rasqueta / Scraper	
7	68172	Cepillo limpieza cobre / Copper cleaner brushes	
	68091	Set curvaturas carraca / Ratchet tube bender set	
1	63172	Abocinador / Pulg flaring tool	mm
	63205	Cortatubos acero / Steel tube cutter	2"
14	67169, 67170, 67171, 67172, 67173, 67174, 67175, 67176, 67177, 67178, 67179, 67180, 67181, 67182	Cortatubos plástico Piraina / Piraina plastic pipe cutter	
1	62200 69501	Formones / Firmer chisels	
14	64616	Cortavariillas / Bolt cutters	8"
	67022	Cutter	
1	69527	Set sierra de coronas / Bimetal hole saws set	
	66073	Espátula / Scraper	
		Navaja / Penknife	
		Tester	

■ 428 PCS.
■ MM / INCH



COD.	PCS.		Medidas en / Sizes in / Mesures en	
68962				110
68963	428		51039	160
55766			51073, 51074	521

PCS.	Composición / Composition / Composition	Descripción / Description / Description	
20	62214, 62215, 62216, 62217, 62218, 62219, 62220, 62221, 62222, 62223, 62224, 62225, 62226, 62227, 62228, 62229, 62180, 62181, 62182, 62183	Alicates Circlips / Circlips pliers	-
27	66400, 66401, 66403, 66405, 66407, 66408, 66409, 66410, 76620, 76621, 76622, 76624, 76625, 76626, 76627, 66438, 66439, 66440, 66441, 66442, 76629, 76630, 66456, 66457, 66458, 66459, 66460	Destornilladores mecánicos, electricistas, Philips, Pozidriv® / Slotted, electrician, Philips, Pozidriv® screwdrivers	-
26	61725, 61726, 61727, 61728, 61729, 61730, 61731, 61732, 61733, 61734, 61735, 61736, 61737, 61738, 61739, 61740, 61741, 61742, 61743, 61744, 61745, 61746, 61747, 61748, 61749, 61750	Llaves combinadas / Combination wrenches	mm
17	60340, 60341, 60342, 60343, 60344, 60345, 60346, 60347, 60348, 60349, 60350, 60351, 60352, 60353, 60354, 60355, 60356	Llaves combinadas / Combination wrenches	inch
	61701, 61702, 61703, 61704, 61705, 61706, 61707, 61708, 61709, 61710, 61711, 61713	Llaves fijas / Open-end wrenches	mm
12	60300, 60301, 60302, 60303, 60304, 60306, 60309, 60310, 60311, 60312, 60313, 60314	Llaves fijas / Open-end wrenches	inch
	61775, 61776, 61777, 61778, 61779, 61780, 61781, 61782, 61783, 61784, 61785, 61787	Llaves acodadas / Double offset ring wrenches	inch
	60380, 60381, 60382, 60383, 60384, 60386, 60389, 60390, 60391, 60392, 60393, 60394	Llaves acodadas / Double offset ring wrenches	inch
25	61960	Juego / Set	1/2", mm, 25 pcs
	61963	Juego / Set	1/2", inch, 25 pcs
26	61870, 61871, 61872, 61873, 61874, 61875, 61876, 61877, 61878, 61879, 61880, 61881, 61882, 61883, 61884, 61885, 61886, 61887, 61888, 61889, 61890, 61891, 61892, 61893, 61894, 61895	Llaves de pipa / Angled sockets	-
23	65302, 65303, 65304, 65305, 65306, 65307, 65308, 65309, 65310, 65311, 65312, 65313, 65314, 61501, 61502, 61503, 61504, 61505, 61506, 61507, 61508, 61509, 61510	Llaves hexagonales / Hexagonal keys	mm
15	65315, 65316, 65317, 65318, 65319, 65320, 65321, 65322, 65323, 65324, 65325, 65326, 65327, 65328, 65329	Llaves hexagonales / Hexagonal keys	inch
7	63401, 63402, 63403, 63404, 63405, 63406, 63407	Botadores octogonales / Octagonal punches	
6	63435, 63436, 63437, 63438, 63439, 63440	Granetes hexagonales / Hexagonal center punches	
3	63178, 63179, 63180	Cortafíos / Chisel	
10	62331, 62332, 62333, 62339, 62340, 62341, 62342, 62343, 62344, 62349	Alicates / Pliers	
9	62241, 62242, 62243, 62244, 62245, 62246, 62247, 62248, 62249	Alicates mini / Mini Pliers	-
2	62135, 62134	Tenazas de canal / Box joint pincers	
1	61112	Llave ajustable / Adjustable wrench	
2	62587, 62590	Extractores / Gear pullers	
	63748	Arco de sierra / Hack Saw	
1	62963	Llave dinamo métrica reversible / Reversible torque wrench	1/2", 40-200 nm
7	69619, 69622, 69614, 69750, 69742, 69729, 69521	Martillos / Hammers	
33	66942	Juego puntas / Bits set	-
1	61016	Llave HD / HD Pipe wrench	12"
3	62177, 62178, 62172	Tenazas Grip / Grip pincers	
6	63498, 63534, 63570, 63606, 63642, 63678	Limas / Files	
	62233	Tijera de chapa / Tin snip	-
1	69534	Tijera electricista / Electrician's scissors	
	65479	Calibre / Caliper	
3	69570, 69572, 69575	Sargentos G / G Clamps	
	65155	Nivel trapezoidal profesional / Professional bridge type spirit level	400 mm
1	66731	Destornillador portapuntas magnético / Screwdriver magnetic bitholder	
10	60693	Juego de vasos impacto / Impact socket sets	mm
11	61267	Juego de vasos impacto / Impact socket sets	inch
1	62124	Tenaza rusa / Tower pincer	9", 10"
2	62438, 62440	Tenaza carpintero / Carpenter pincer	
4	69529	Set 4 pinzas / Set 4 tweezers	
1	62493	Alicate de terminales / Crimping pliers	-
12	66846, 66848, 66849, 66850, 66851, 66852, 66853, 66854, 66862, 66863, 66864, 66865	Juego destornilladores Microtronic / Microtronic screwdriver set	
1	69504	Magnetizador-desmagnetizador / Magnetizer-demagnetizer	
	65362	Flexómetros / Measuring tape	3m/10'
6	63714, 63715, 63716, 63717, 63718, 63719	Limas de aguja / Needle files	
	65595	Recogedor telescópico / Telescopic joing pick up	-
	65586	Espejo articulado / Joint telescopic mirror	
1	65774	Regla / Ruler	300 mm
	63119	Cortatubos cobre / Cooper tube cutter	42 mm
	63376	Rasqueta / Scraper	-
	63207	Cepillo limpieza cobre / Copper cleaner brushes	
7	68172	Set curvatubos carraca / Ratchet tube bender set	mm
	68091	Abocinador / Pulg flaring tool	mm/inch
1	63172	Cortatubos acero / Steel tube cutter	2"
	63205	Cortatubos plástico Piraina / Piraina plastic pipe cutter	-
	62200	Cortavarrillas / Bolt cutters	8"
1	69501	Cutter	
9	64615	Set sierra de coronas / Bimetal hole saws set	-
1	66073	Tester	

■ 191 PCS.
■ MM / INCH



COD.	PCS.		Medidas en / Sizes in / Mesures en	
68964		-		39
68965	191	51025	mm/inch	89
55767		51073		194

PCS.	Composición / Composition / Composition	Descripción / Description / Description	
16	62214, 62215, 62216, 62217, 62218, 62219, 62220, 62221, 62222, 62223, 62224, 62225, 62226, 62227, 62228, 62229	Alicates Circlips / Circlips pliers	
18	66400, 66401, 66403, 66407, 66408, 76621, 76622, 76624, 76625, 76626, 66439, 66440, 66441, 76629, 76630, 66457, 66458, 66459	Destornilladores mecánicos, electricistas, Philips, Pozidriv® / Slotted, electrician, Philips, Pozidriv® screwdrivers	-
12	61725, 61726, 61727, 61728, 61729, 61730, 61731, 61732, 61733, 61734, 61735, 61736 60341, 60342, 60343, 60344, 60345, 60347, 60348, 60349, 60351, 60352, 60353, 60354	Llaves combinadas / Combination wrenches	mm inch
	61701, 61702, 61703, 61704, 61705, 61706, 61707, 61708	Llaves fijas / Open-end wrenches	mm
8	60302, 60303, 60304, 60306, 60309, 60310, 60311, 60312 61775, 61776, 61777, 61778, 61779, 61780, 61781, 61782 60382, 60383, 60384, 60385, 60386, 60389, 60390, 60391	Llaves acodadas / Double offset ring wrenches	mm inch
17	61796 61798	Juego llaves vaso / Socket wrench set	1/2", mm 1/2", inch
10	61503, 61504, 61505, 61506, 61508, 61509, 61510, 65307, 65308, 65310 65318, 65319, 65320, 65321, 65322, 65323, 65324, 65325, 65326, 65327	Llaves hexagonales / Hexagonal keys	mm inch
5	63402, 63403, 63404, 63405, 63406	Botadores / Punches	
2	63178, 63179,	Cortafíos / Chisel	
4	62340, 62343, 62344, 62349	Alicates / Pliers	
1	62135	Tenazas de canal / Box joint pliers	
	61112	Llave ajustable / Adjustable wrench	
2	62587, 62590	Extractores / Gear pullers	
1	63748	Arco de sierra / Hack Saw	
4	69619, 69622, 69614, 69750	Martillos / Hammers	
1	61016	Llave HD / HD Pipe wrench	12"
3	62177, 62178, 62172	Tenazas Grip / Grip pliers	
6	63498, 63534, 63570, 63606, 63642, 63678	Limas / Files	
	62233	Tijera de chapa / Tin snip	
	69534	Tijera electricista / Electrician's scissors	
1	65479	Calibre / Caliper	
	69572	Sargentos G / G Clamps	
	62124	Tenaza rusa / Tower pincer	10"
2	62438, 62440	Tenaza carpintero / Carpenter pincer	
4	69529	Set 4 pinzas / Set 4 tweezers	-
	62493	Alicate de terminales / Crimping pliers	
	65362	Flexómetros / Measuring tape	3 m/10'
	65595	Recogedor telescópico / Telescopic joing pick up	-
1	63119	Cortatubos cobre / Cooper tube cutter	42 mm
	69501	Cutter	-
	66073	Tester	-

■ 290 PCS.
■ MM / INCH



COD.	PCS.		Medidas en / Sizes in / Mesures en	
69774				26
69775	290		mm/inch	
69784		51075		73

PCS.	Composición / Composition / Composition	Descripción / Description / Description	
3	62214, 62222, 62183	Alicates Circlips / Circlips pliers	
7	62340, 62342, 62344, 62333, 62337, 62346, 62338	Alicates / Pliers	
1	62494	Alicate de terminales / Crimping pliers	-
9	63790, 63792, 63793, 63794, 63795, 63796, 63798, 63799, 63801	Llaves combinadas de carraca / Combination ratchet wrenches	
6	62666, 62667, 62668, 62669, 62671, 62673		
13	60340, 60341, 60342, 60343, 60344, 60345, 60347, 60348, 60349, 60351, 60352, 60353, 60354	Llaves combinadas / Combination wrenches	inch
14	61725, 61726, 61727, 61728, 61729, 61730, 61731, 61732, 61733, 61734, 61735, 61736, 61737, 61738		mm
1	65550	Galgas de espesores / Feeler gauge	
	69501	Cutter	
4	63429, 63431, 63432, 63436	Granetes / Center punches	
1	62828	Extractor / Gear puller	
	62847	Cinzel mecánico / Flat cold chisel	
7	63408, 63409, 63410, 63411, 63412, 63413, 63414	Botadores cónicos	
	63394, 63395, 63396, 63397, 63398, 63399, 63400	Botadores cilíndricos	
1	62707	Tenaza de canal / Box joint	
	61500		mm
	61516	Juego llaves Allen / Allen keys wrenches Set	inch
10	61496		mm
	61495	Juego llaves Allen bola / Set of hexagonal key wrenches ball type	inch
4	66438, 66439, 66440, 66441	Destornilladores Philips / Philips screwdriver	
3	66402, 66403, 66405	Destornilladores mecánicos / Slotted screwdrivers	
4	66420, 66422, 66423, 66425	Destornilladores electricistas / Electrician screwdrivers	
2	66457, 66458	Destornilladores Pozidriv® / Pozidriv® screwdrivers	
33	66942	Juego puntas / Bits set	-
4	66733, 66734, 66735, 66736	Puntas atornilladoras con vaso planas / Flat socket bits	
3	66737, 66738, 66739	Puntas atornilladoras con vaso Philips / Philips socket bits	
5	66743, 66744, 66745, 66746, 66747	Puntas atornilladoras con vaso hexagonales / Hexagonal socket bits	
9	66748, 66749, 66750, 66751, 66752, 66753, 66754, 66755, 66756	Puntas atornilladoras con vaso Torx® / Torx® socket bits	
24	61791		mm/inch, 1/4", 24 pcs
42	61792	Juego vasos / Socket set	mm/inch, 3/8", 42 pcs
41	61793		mm/inch, 1/2", 41 pcs

■ 171 PCS.

■ MM



COD.	PCS.	Medidas en / Sizes in / Mesures en	Kg
55793	-	-	22
55794	171	51025 mm	72
69989	-	-	-

PCS.	Composición / Composition / Composition	Descripción / Description / Description
12	66400, 66401, 66403, 66405, 66439, 66440, 66478, 66479, 66480, 66481, 66483, 66484	Destornilladores Mastertork: mecánico, Philips, Torx® / Screwdrivers Mastertork: slotted, Philips, Torx®
3	62332, 62339, 62343	Alicates Titacrom®: universal, telefonista y corte diagonal / Pliers Titacrom®: combination, long nose, diagonal plier
26	61725, 61726, 61727, 61728, 61729, 61730, 61731, 61732, 61733, 61734, 61735, 61736, 61737, 61738, 61739, 61740, 61741, 61742, 61743, 61744, 61745, 61746, 61747, 61748, 61749, 61750	Llaves combinadas cromado aeroespacial / Aerospaceal chrome plating combination wrenches
46	61800, 61801, 61802, 61803, 61804, 61805, 61806, 61807, 61808, 61809, 61810, 61811, 61812, 61813, 61814, 61815, 61816, 61817, 61818, 61819, 61822, 61823, 61311, 61312, 61313, 61314, 61315, 61316, 61317, 61318, 61319, 61320, 61321, 65044, 65045, 65046, 65047, 65048, 65049, 65050, 65051, 65052, 65053, 65054, 65055, 65056	Llaves de vaso / Socket wrenches
2	61438, 61440	Mango correr en T / Sliding "T" handle
4	61442, 61444, 61455, 61458	Alargadera / Extension
2	62603, 62606	Llave de carraca reversible / Reversible ratchet handle
	61435, 61437	Articulación universal / Universal joint
1	66731	Destornillador portapuntas magnético / Screwdriver magnetic bit holder
15	66124, 66125, 66126, 66136, 66137, 66141, 66142, 66148, 66149, 66172, 66173, 66193, 66194, 66195, 66196	Puntas de destornillador Masterbit / Masterbit bits
3	61501, 61502, 61503	Llaves hexagonales / Hexagonal keys
1	66264	Adaptador portapuntas magnético / Magnetic bit holder
13	66733, 66734, 66735, 66737, 66738, 66740, 66741, 66748, 66750, 66751, 66752, 66753, 66755	Puntas atornilladoras con vaso / Socket bits
1	63742	Arco de sierra / Hack Saw
3	62169, 62170, 62171	Tijera articulada / Aviation tin snip
1	63876	Cortador / Cutter
3	63178, 63179, 63180	Cortafíos / Chisel
6	63394, 63395, 63396, 63397, 63398, 63399	Botador / Pin punch
1	69621	Martillo alemán / German type machinist's hammer
	55326	Maceta de nylon / Nylon hammer
11	63498, 63570, 63606, 63642, 63678, 63714, 63715, 63716, 63717, 63718, 63719	Limas / Files
4	62180, 62181, 62182, 62183	Alicates Circlips / Circlips pliers
	62172	Tenaza Grip / Grip plier
	61944	Llave ajustable / Adjustable wrench
	62707	Tenaza de canal / Box joint
	69534	Tijera electricista / Electrician's scissors
1	62494	Tenaza para engastar / Crimping plier
	62151	Tenaza cortables / Cable cutters
	65167	Flexómetro / Measuring tape
	65293	Nivel trapezoidal profesional / Professional bridge type spirit level
	65480	Calibre / Caliper
	66073	Buscapolos / Voltage tester

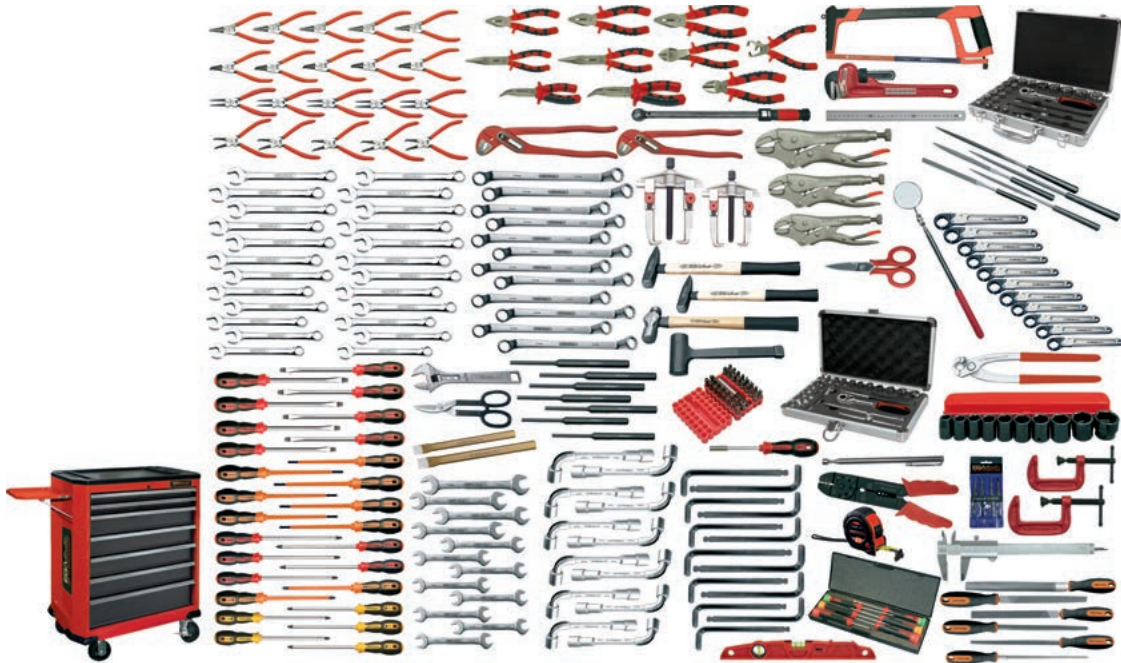
JUEGOS MANTENIMIENTO INDUSTRIAL / INDUSTRIAL MAINTENANCE SETS / SETS DE MAINTENANCE INDUSTRIELLE / INDUSTRIELLE INSTANDHANDLUNG SETS / KIT MANUTENZIONE INDUSTRIALE / JOGOS DE MANUTENÇÃO INDUSTRIAL / ИНДУСТРИАЛЬНЫЕ НАБОРЫ
299 PCS.
MM

COD.	PCS.	Medidas en / Sizes in / Mesures en	Kg
68966	-	-	67
68967	299	51039	117
55768	-	51074	323

PCS.	Composición / Composition / Composition	Descripción / Description / Description	
20	62214, 62215, 62216, 62217, 62218, 62219, 62220, 62221, 62222, 62223, 62224, 62225, 62226, 62227, 62228, 62229, 62180, 62181, 62182, 62183	Alicates Circlips / Circlip pliers	
27	66400, 66401, 66403, 66405, 66407, 66408, 66409, 66410, 76620, 76621, 76622, 76624, 76625, 76626, 76627, 66438, 66439, 66440, 66441, 66442, 76629, 76630, 66456, 66457, 66458, 66459, 66460	Destornilladores mecánicos, electricistas, Philips, Pozidriv® / Slotted, electrician, Philips, Pozidriv® screwdrivers	
26	61725, 61726, 61727, 61728, 61729, 61730, 61731, 61732, 61733, 61734, 61735, 61736, 61737, 61738, 61739, 61740, 61741, 61742, 61743, 61744, 61745, 61746, 61747, 61748, 61749, 61750	Llaves combinadas / Combination wrenches	mm
12	61701, 61702, 61703, 61704, 61705, 61706, 61707, 61708, 61709, 61710, 61711, 61713	Llaves fijas / Open-end wrenches	
	61775, 61776, 61777, 61778, 61779, 61780, 61781, 61782, 61783, 61784, 61785, 61787	Llaves acodadas / Double offset ring wrenches	
25	61960	Juego / Set	1/2", mm, 25 pcs
12	61872, 61874, 61875, 61877, 61878, 61881, 61883, 61886, 61888, 61891, 61894, 61895	Llaves de pipa / Angled sockets	
14	61501, 61502, 61503, 61504, 61505, 61506, 61508, 61509, 61510, 65307, 65308, 65310, 65311, 65313	Llaves hexagonales / Hexagonal keys	mm
7	63401, 63402, 63403, 63404, 63405, 63406, 63407	Botadores / Punches	
2	63178, 63179	Cortafíos / Chisel	
10	62331, 62332, 62333, 62339, 62340, 62341, 62342, 62343, 62344, 62349	Alicates / Pliers	
2	62135, 62134	Tenazas de canal / Box joint pincers	
1	61112	Llave ajustable / Adjustable wrench	
2	62587, 62590	Extractores / Gear pullers	
1	63748	Arco de sierra / Hack Saw	

PCS.	Composición / Composition / Composition	Descripción / Description / Description	
29	61958	Juego vasos / Socket set	1/4"
1	62963	Llave dinamométrica reversible / Reversible torque wrench	1/2", 40-200 nm
4	69619, 69622, 69614, 69750	Martillos / Hammers	
33	66942	Juego puntas / Bits set	
1	61016	Llave HD / HD Pipe wrench	12"
3	62177, 62178, 62172	Tenazas Grip / Grip pincers	
6	63498, 63534, 63570, 63606, 63642, 63678	Limas / Files	
	62233	Tijera de chapa / Tin snip	
1	69534	Tijera electricista / Electrician's scissors	
	65479	Calibre / Caliper	
2	69571, 69574	Sargentos G / G Clamps	
1	65155	Nivel trapezoidal profesional / Professional bridge type spirit level	400 mm
	66731	Destornillador portapuntas magnético / Screwdriver magnetic bitholder	-
10	60693	Juego de vasos impacto / Impact socket sets	
1	62124	Tenaza rusa / Tower pincer	10"
4	69529	Set 4 pinzas / Set 4 tweezers	
1	62493	Alicate de terminales / Crimping pliers	
11	65089, 65090, 65091, 65092, 65093, 65095, 65096, 65098, 65099, 65100, 65102	Llaves de carraca para racores	
6	66999	Juego destornilladores Microtronic / Microtronic screwdriver set	
1	65172	Flexómetro Rallye II / Rallye II Measuring tape	3 m/16 mm
6	63714, 63715, 63716, 63717, 63718, 63719	Limas de aguja / Needle files	
	65595	Recogedor telescópico / Telescopic joing pick up	
1	65586	Espejo articulado / Joint telescopic mirror	
	65774	Regla / Ruler	300 mm

■ 286 PCS.

■ INCH



COD.	PCS.	Medidas en / Sizes in / Mesures en	Kg
68968	-	-	55
68969	286	inch	105
55769	-	-	311

PCS.	Composición / Composition / Composition	Descripción / Description / Description	
20	62214, 62215, 62216, 62217, 62218, 62219, 62220, 62221, 62222, 62223, 62224, 62225, 62226, 62227, 62228, 62229, 62180, 62181, 62182, 62183	Alicates Circlips / Circlips pliers	
27	66400, 66401, 66403, 66405, 66407, 66408, 66409, 66410, 76620, 76621, 76622, 76624, 76625, 76626, 76627, 66438, 66439, 66440, 66441, 66442, 76629, 76630, 66456, 66457, 66458, 66459, 66460	Destornilladores mecánicos, electricistas, Philips, Pozidriv® / Slotted, electrician, Philips, Pozidriv® screwdrivers	
17	60340, 60341, 60342, 60343, 60344, 60345, 60346, 60347, 60348, 60349, 60350, 60351, 60352, 60353, 60354, 60355, 60356	Llaves combinadas / Combination wrenches	
12	60300, 60301, 60302, 60303, 60304, 60306, 60309, 60310, 60311, 60312, 60313, 60314	Llaves fijas / Open-end wrenches	inch
12	60380, 60381, 60382, 60383, 60384, 60386, 60389, 60390, 60391, 60392, 60393, 60394	Llaves acodadas / Double offset ring wrenches	
25	61963	Juego / Set	1/2", inch, 25 pcs
5	65113, 65114, 65115, 65116, 65117	Llaves de estrella carraca / Ratchet wrench	-
15	65315, 65316, 65317, 65318, 65319, 65320, 65321, 65322, 65323, 65324, 65325, 65326, 65327, 65328, 65329	Llaves hexagonales / Hexagonal keys	inch
7	63401, 63402, 63403, 63404, 63405, 63406, 63407	Botadores / Punches	
2	63178, 63179	Cortafíos / Chisel	
10	62331, 62332, 62333, 62339, 62340, 62341, 62342, 62343, 62344, 62349	Alicates / Pliers	
2	62135, 62134	Tenazas de canal / Box joint pliers	
1	61112	Llave ajustable / Adjustable wrench	
2	62587, 62590	Extractores / Gear pullers	
1	63748	Arco de sierra / Hack Saw	
29	61961	Juego vasos / Socket set	1/4", inch
1	62963	Llave dinamo métrica reversible / Reversible torque wrench	1/2", 40-200 nm
4	69619, 69622, 69614, 69750	Martillos / Hammers	
33	66942	Juego puntas / Bits set	

PCS.	Composición / Composition / Composition	Descripción / Description / Description	
1	61016	Llave HD / HD Pipe wrench	12"
3	62177, 62178, 62172	Tenazas Grip / Grip pliers	
6	63498, 63534, 63570, 63606, 63642, 63678	Limas / Files	
	62233	Tijera de chapa / Tin snip	
1	69534	Tijera electricista / Electrician's scissors	
	65485	Calibre / Caliper	
2	69571, 69574	Sargentos G / G Clamps	
	65155	Nivel trapezoidal profesional / Professional bridge type spirit level	400 mm
1	66731	Destornillador portapuntas magnético / Screwdriver magnetic bitholder	
11	61267	Juego de vasos impacto / Impact socket sets	
1	62124	Tenaza rusa / Tower pincer	10"
4	69529	Set 4 pinzas / Set 4 tweezers	
1	62493	Alicate de terminales / Crimping pliers	
11	62666, 62667, 62668, 62669, 62670, 62671, 62672, 62673, 62674, 62675, 62676	Llave Mastergear / Mastergear Wrench	
6	66999	Juego destornilladores Microtronic / Microtronic screwdriver set	
1	65172	Flexómetro Rallye II / Rallye II Measuring tape	3 m/16 mm
6	63714, 63715, 63716, 63717, 63718, 63719	Limas de aguja / Needle files	
	65595	Recogedor telescópico / Telescopic joing pick up	
1	65586	Espejo articulado / Joint telescopic mirror	
	65773	Regla / Ruler	300 mm

■ 152 PCS.

■ MM



COD.	PCS.		Medidas en / Sizes in / Mesures en	
68970		-		35
68971	152	51025	mm	85
55770		51117	●	190

PCS.	Composición / Composition / Composition	Descripción / Description / Description	
16	62214, 62215, 62216, 62217, 62218, 62219, 62220, 62221, 62222, 62223, 62224, 62225, 62226, 62227, 62228, 62229	Alicates Circlips / Circlips pliers	
18	66400, 66401, 66403, 66407, 66408, 76621, 76622, 76624, 76625, 76626, 66439, 66440, 66441, 76629, 76630, 66457, 66458, 66459	Destornilladores mecánicos, electricistas, Philips, Pozidriv® / Slotted, electrician, Philips, Pozidriv® screwdrivers	-
12	61725, 61726, 61727, 61728, 61729, 61730, 61731, 61732, 61733, 61734, 61735, 61736	Llaves combinadas / Combination wrenches	
8	61701, 61702, 61703, 61704, 61705, 61706, 61707, 61708	Llaves fijas / Open-end wrenches	mm
	61775, 61776, 61777, 61778, 61779, 61780, 61781, 61782	Llaves acodadas / Double offset ring wrenches	
25	61960	Juego / Set	1/2", mm, 25 pcs
10	61503, 61504, 61505, 61506, 61508, 61509, 61510, 65307, 65308, 65310	Llaves hexagonales / Hexagonal keys	mm
5	63402, 63403, 63404, 63405, 63406	Botadores / Punches	
2	63178, 63179	Cortafíos / Chisel	
6	62332, 62340, 62342, 62343, 62344, 62349	Alicates / Pliers	
1	62135	Tenazas de canal / Box joint pincers	-
	61112	Llave ajustable / Adjustable wrench	
2	62587, 62590	Extractores / Gear pullers	
	63748	Arco de sierra / Hack Saw	
1	62963	Llave dinamo métrica reversible / Reversible torque wrench	1/2", 40-200 nm
4	69619, 69622, 69614, 69750	Martillos / Hammers	-
1	61016	Llave HD / HD Pipe wrench	12"
3	62177, 62178, 62172	Tenazas Grip / Grip pincers	
6	63498, 63534, 63570, 63606, 63642, 63678	Limas / Files	
	62233	Tijera de chapa / Tin snip	-
1	69534	Tijera electricista / Electrician's scissors	
	65479	Calibre Caliper	
2	69571, 69574	Sargentos G / G Clamps	
	65155	Nivel trapezoidal profesional / Professional bridge type spirit level	400 mm
1	62124	Tenaza rusa / Tower pincer	10"
4	69529	Set 4 pinzas / Set 4 tweezers	-
1	62493	Alicate de terminales / Crimping pliers	
	65172	Flexómetro Rallye II / Rallye II Measuring tape	3 m/16 mm
6	63714, 63715, 63716, 63717, 63718, 63719	Limas de aguja / Needle files	
	65595	Recogedor telescópico / Telescopic joing pick up	-
1	65586	Espejo articulado / Joint telescopic mirror	
	65774	Regla / Ruler	300 mm

■ 152 PCS.

■ INCH





COD.	PCS.		Medidas en / Sizes in / Mesures en	
68972		-		33
68973	152	51025	inch	83
55771		51117	●	128

PCS.	Composición / Composition / Composition	Descripción / Description / Description	
16	62214, 62215, 62216, 62217, 62218, 62219, 62220, 62221, 62222, 62223, 62224, 62225, 62226, 62227, 62228, 62229	Alicates Circlips / Circlips pliers	
18	66400, 66401, 66403, 66407, 66408, 76621, 76622, 76624, 76625, 76626, 66439, 66440, 66441, 76629, 76630, 66457, 66458, 66459	Destornilladores mecánicos, electricistas, Philips, Pozidriv® / Slotted, electrician, Philips, Pozidriv® screwdrivers	-
12	60341, 60342, 60343, 60344, 60345, 60347, 60348, 60349, 60351, 60352, 60353, 60354	Llaves combinadas / Combination wrenches	
8	60302, 60303, 60304, 60306, 60309, 60310, 60311, 60312	Llaves fijas / Open-end wrenches	inch
	60382, 60383, 60384, 60385, 60386, 60389, 60390, 60391	Llaves acodadas / Double offset ring wrenches	
25	61963	Juego / Set	1/2", inch, 25 pcs
10	65318, 65319, 65320, 65321, 65322, 65323, 65324, 65325, 65326, 65327	Llaves hexagonales / Hexagonal keys	inch
5	63402, 63403, 63404, 63405, 63406	Botadores / Punches	
2	63178, 63179	Cortafíos / Chisel	
6	62332, 62340, 62342, 62343, 62344, 62349	Alicates / Pliers	
1	62135	Tenazas de canal / Box joint pincers	-
	61112	Llave ajustable / Adjustable wrench	
2	62587, 62590	Extractores / Gear pullers	
1	63748	Arco de sierra / Hack Saw	
	62963	Llave dinamométrica / Torque wrench	1/2", 40-200 nm
4	69619, 69622, 69614, 69750	Martillos / Hammers	-
1	61016	Llave HD / HD Pipe wrench	12"
3	62177, 62178, 62172	Tenazas Grip / Grip pincers	
6	63498, 63534, 63570, 63606, 63642, 63678	Limas / Files	
	62233	Tijera de chapa / Tin snip	-
1	69534	Tijera electricista / Electrician's scissors	
	65485	Calibre / Caliper	
2	69571, 69574	Sargentos G / G Clamps	
1	65155	Nivel trapezoidal profesional / Professional bridge type spirit level	400 mm
	62124	Tenaza rusa / Tower pincer	10"
4	69529	Set 4 pinzas / Set 4 tweezers	
1	62493	Alicete de terminales / Crimping pliers	-
	65172	Flexómetro Rallye II / Rallye II Measuring tape	3 m/16 mm
6	63714, 63715, 63716, 63717, 63718, 63719	Limas de aguja / Needle files	
	65595	Recogedor telescópico / Telescopic joing pick up	-
1	65586	Espejo articulado / Joint telescopic mirror	
	65773	Regla / Ruler	300 mm

JUEGO AERONÁUTICA / AVIATION SET / SET AÉRONAUTIQUE / WERKZEUG SET FÜR LUFTFAHRT / KIT PER AEREONAUTICA / JOGO AERONÁUTICA / АВИАЦИОННЫЙ НАБОР
■ 158 PCS.

■ INCH

COD.	PCS.		Medidas en / Sizes in / Mesures en		
68974					21
68975	158		inch		71
55772		51039			

PCS.	Composición / Composition / Composition	Descripción / Description / Description	
10	63380, 63381, 63382, 63401, 63402, 63403, 63404, 63405, 63406, 63407	Botadores / Punches	
6	63498, 63534, 63570, 63606, 63642, 63678	Limas / Files	
3	63178, 63179, 63180	Cortafíos / Chisel	
12	66874, 66875, 66877, 66880, 66883, 66885, 66897, 66898, 66899, 66938, 66901, 66902, 65479	Destornilladores Rotork / Rotork Screwdrivers	
	61112	Calibre / Caliper	
1	62135	Llave ajustable / Adjustable wrench	
	61226	Tenazas de canal / Box joint pliers	
11		Set dinámométrica / Reversible torque wrench set	
4	62333, 62343, 62337, 62339	Alicates / Pliers	
11	62695, 62696, 62697, 62698, 62699, 62700, 62701, 62702, 62703, 62704, 62705	Llaves de Mastergear Spine / Spine Mastergear wrenches	
15	60380, 60381, 60382, 60383, 60384, 60385, 60386, 60387, 60388, 60389, 60390, 60391, 60392, 60393, 60394	Llaves acodadas / Double offset ring wrenches	inch
14	60341, 60342, 60343, 60344, 60345, 60346, 60347, 60348, 60349, 60350, 60351, 60352, 60353, 60354	Llaves combinadas / Combination wrenches	
33	61963	Juego de vasos / Socket set	1/2"
1	63748	Arco de sierra / Hack Saw	
12	65315, 65316, 65317, 65318, 65319, 65320, 65321, 65322, 65323, 65324, 65325	Llaves hexagonales / Hexagonal keys	inch
1	69501	Cutter	
	65362	Flexómetros / Measuring tape	3 m/10'
2	69619, 55326	Martillos / Hammers	
	65595	Recogedor telescópico / Telescopic joing pick up	
1	65550	Galga de espesores / Feeler gauge	
6	63714, 63715, 63716, 63717, 63718, 63719	Limas de aguja / Needle files	
4	69529	Set 4 pinzas / Set 4 tweezers	
1	69534	Tijera electricista / Electrician's scissors	
3	62178, 62135, 62136	Tenazas Grip / Grip pliers	
	65586	Espejo articulado / Joint telescopic mirror	
1	62188	Tijera aviación articulada reforzada / Reinforced aviation tin snips	
	62136	Tenaza de sifón / Syphon plier	

JUEGOS MECÁNICA / SETS FOR MECHANICS / SETS DE MÉCANICIENS / WERKZEUG SETS FÜR MECHANIKER / KIT MECCANICA / JOGO DE MECÂNICA / МЕХАНИЧЕСКИЕ НАБОРЫ

419 PCS.

MM





COD.	PCS.		Medidas en / Sizes in / Mesures en	
68976				127
68977	419	50950	mm	222
55773		51074, 51073		538

PCS.	Composición / Composition / Composition	Descripción / Description / Description	
20	62214, 62215, 62216, 62217, 62218, 62219, 62220, 62221, 62222, 62223, 62224, 62225, 62226, 62227, 62228, 62229, 62180, 62181, 62182, 62183	Alicates Circlips / Circlips pliers	
9	66400, 66401, 66403, 66405, 66407, 66408, 66409, 66410, 66525	Destornilladores mecánicos / Slotted screwdrivers	
7	76620, 76621, 76622, 76624, 76625, 76626, 76627	Destornilladores electricistas / Electrician screwdrivers	
6	66438, 66439, 66440, 66441, 66442, 66526 66456, 66457, 66458, 66459, 66460, 66527	Destornilladores Philips / Philips screwdriver Destornilladores Pozidriv® / Pozidriv® screwdrivers	
13	66474, 66475, 66476, 66477, 66478, 66479, 66480, 66481, 66482, 66483, 66484, 66485, 66486	Destornilladores Torx® / Torx® screwdrivers	
7	66571, 66572, 66573, 66574, 66575, 66576, 66577	Destornilladores T-Mastertork / T-Mastertork screwdrivers	
16	69870	Set reversible Mastergear / Set rev. Mastergear	
13	61824, 61825, 61826, 61827, 61828, 61829, 61830, 61831, 61832, 61833, 61834, 61835, 61836	Llaves de tubo doble boca / Socket double ended wrench	
18	61840, 61841, 61842, 61843, 61844, 61845, 61846, 61847, 61848, 61849, 61850, 61851, 61852, 61853, 61854, 61855, 61856, 61858	Llaves articuladas en T / T-handle wrenches with universal joint	
32	61725, 61726, 61727, 61728, 61729, 61730, 61731, 61732, 61733, 61734, 61735, 61736, 61737, 61738, 61739, 61740, 61741, 61742, 61743, 61744, 61745, 61746, 61747, 61748, 61749, 61750, 60951, 60952, 60953, 60954, 60955, 60956	Llaves combinadas / Combination wrenches	
14	61701, 61702, 61703, 61704, 61705, 61706, 61707, 61708, 61709, 61710, 61711, 61712, 61713	Llaves fijas / Open-end wrenches	mm
16	61775, 61776, 61777, 61778, 61779, 61780, 61781, 61782, 61783, 61784, 61785, 61786, 61787, 61788, 61789, 61790	Llaves acodadas / Double offset ring wrenches	
25	61960	Juego / Set	
26	61870, 61871, 61872, 61873, 61874, 61875, 61876, 61877, 61878, 61879, 61880, 61881, 61882, 61883, 61884, 61885, 61886, 61887, 61888, 61889, 61890, 61891, 61892, 61893, 61894, 61895	Llaves de pipa / Angled sockets	1/2", mm, 26 pcs
23	65302, 65303, 65304, 65305, 65306, 65307, 65308, 65309, 65310, 65311, 65312, 65313, 65314, 61501, 61502, 61503, 61504, 61505, 61506, 61507, 61508, 61509, 61510	Llaves hexagonales / Hexagonal keys	mm
7	63401, 63402, 63403, 63404, 63405, 63406, 63407	Botadores octogonales / Octagonal punches	
6	63435, 63436, 63437, 63438, 63439, 63440	Granetes hexagonales / Hexagonal center punches	
3	63178, 63179, 63180	Cortafíos / Chisel	
13	62331, 62332, 62333, 62337, 62338, 62339, 62340, 62341, 62342, 62343, 62344, 62345, 62349	Alicates / Pliers	
3	62133, 62135, 62134	Tenazas de canal / Box joint pincers	
2	61112, 61114	Llave ajustable / Adjustable wrench	
5	62586, 62587, 62588, 62589, 62590	Extractores / Gear pullers	
1	63748	Arco de sierra / Hack Saw	
29	61958	Juego vasos / Socket set	1/4", mm
1	62963	Llave dinamométrica / Torque wrench	1/2" 40-200 nm
7	69619, 69622, 69614, 69750, 69742, 69729, 69521	Martillos / Hammers	
33	66942	Juego puntas / Bits set	
1	61016	Llave HD / HD Pipe wrench	12"
3	62177, 62178, 62172	Tenazas Grip / Grip pincers	
6	63498, 63534, 63570, 63606, 63642, 63678	Limas / Files	
	62233	Tijera de chapa / Tin snip	
	69534	Tijera electricista / Electrician's scissors	
	65479	Calibre / Caliper	
1	65155	Nivel trapezoidal profesional / Professional bridge type spirit level	400 mm
	66731	Destornillador portapuntas magnético / Screwdriver magnetic bitholder	
10	60693	Juego de vasos impacto / Impact socket sets	mm
4	69529	Set 4 pinzas / Set 4 tweezers	
1	62493	Alicate de terminales / Crimping pliers	
11	65089, 65090, 65091, 65092, 65093, 65095, 65096, 65098, 65099, 65100, 65102	Llaves de carraca para racores	
1	69504	Magnetizador-desmagnetizador / Magnetizer-demagnetizer	
	65362	Flexómetro / Measuring tape	3 m, mm/inch
6	63714, 63715, 63716, 63717, 63718, 63719	Limas de aguja / Needle files	
	65595	Recogedor telescópico / Telescopic joing pick up	
	65586	Espejo articulado / Joint telescopic mirror	
	65774	Regla / Ruler	300 mm
	63119	Cortatubos cobre / Cooper tube cutter	42 mm
1	63172	Cortatubos acero / Steel tube cutter	2"
	63205	Cortatubos plástico Piraina / Piraina plastic pipe cutter	
	69501	Cutter	
	51259	Multímetro digital para automóviles / Automotive digital multimeter	
	69527	Navaja / Penknife	

■ 337 PCS.

■ INCH



COD.	PCS.		Medidas en / Sizes in / Mesures en	
68978		-		87
68979	337	50950	inch	182
55774		51074	●	343

PCS.	Composición / Composition / Composition	Descripción / Description / Description	
20	62214, 62215, 62216, 62217, 62218, 62219, 62220, 62221, 62222, 62223, 62224, 62225, 62226, 62227, 62228, 62229, 62180, 62181, 62182, 62183	Alicates Circlips / Circlips pliers	
9	66400, 66401, 66403, 66405, 66407, 66408, 66409, 66410, 66525	Destornilladores mecánicos / Slotted screwdrivers	
7	76620, 76621, 76622, 76624, 76625, 76626, 76627	Destornilladores electricistas / Electrician screwdrivers	
5	66438, 66439, 66440, 66441, 66442, 66526 66456, 66457, 66458, 66459, 66460, 66527	Destornilladores Philips / Philips screwdriver Destornilladores Pozidriv® / Pozidriv® screwdrivers	
13	66474, 66475, 66476, 66477, 66478, 66479, 66480, 66481, 66482, 66483, 66484, 66485, 66486	Destornilladores Torx® / Torx® screwdrivers	
7	66571, 66572, 66573, 66574, 66575, 66576, 66577	Destornilladores T-Mastertork / T-Mastertork screwdrivers	
18	61840, 61841, 61842, 61843, 61844, 61845, 61846, 61847, 61848, 61849, 61850, 61851, 61852, 61853, 61854, 61855, 61856, 61858	Llaves articuladas en T / T-handle wrenches with universal joint	
23	60340, 60341, 60342, 60343, 60344, 60345, 60346, 60347, 60348, 60349, 60350, 60351, 60352, 60353, 60354, 60355, 60356, 60357, 60358, 60957, 60958, 60959, 60960	Llaves combinadas / Combination wrenches	
15	60300, 60301, 60302, 60303, 60304, 60305, 60306, 60307, 60308, 60309, 60310, 60311, 60312, 60313, 60314 60380, 60381, 60382, 60383, 60384, 60385, 60386, 60387, 60388, 60389, 60390, 60391, 60392, 60393, 60394	Llaves fijas / Open-end wrenches Llaves acodadas / Double offset ring wrenches	inch
25	61963	Llaves de vaso, extensiones, carraca, mango corredizo en T, articulación universal	1/2", exten. 5" - 10"
15	65315, 65316, 65317, 65318, 65319, 65320, 65321, 65322, 65323, 65324, 65325, 65326, 65327, 65328, 65329	Llaves hexagonales / Hexagonal keys	inch
7	63401, 63402, 63403, 63404, 63405, 63406, 63407	Botadores octogonales / Octagonal punches	
6	63435, 63436, 63437, 63438, 63439, 63440	Granetes hexagonales / Hexagonal center punches	
3	63178, 63179, 63180	Cortafíos / Chisel	
13	62331, 62332, 62333, 62337, 62338, 62339, 62340, 62341, 62342, 62343, 62344, 62345, 62349	Alicates / Pliers	
3	62133, 62135, 62134	Tenazas de canal / Box joint pincers	
2	61112, 61114	Llave ajustable / Adjustable wrench	
5	62586, 62587, 62588, 62589, 62590	Extractores / Gear pullers	
1	63748	Arco de sierra / Hack Saw	
29	61961	Juego vasos / Socket set	1/4", inch
1	62963	Llave dinamométrica reversible / Reversible torque wrench	1/2", 40-200 nm
7	69619, 69622, 69614, 69750, 69742, 69729, 69521	Martillos / Hammers	
33	66942	Juego puntas / Bits set	
1	61016	Llave HD / HD Pipe wrench	12"
3	62177, 62178, 62172	Tenazas Grip / Grip pincers	
6	63498, 63534, 63570, 63606, 63642, 63678	Limas / Files	
	62233	Tijera de chapa / Tin snip	
	69534	Tijera electricista / Electrician's scissors	
	65479	Calibre / Caliper	
1	65155	Nivel trapezoidal profesional / Professional bridge type spirit level	400 mm
	66731	Destornillador portapuntas magnético / Screwdriver magnetic bitholder	
11	61267	Juego de vasos impacto / Impact socket sets	inch
4	69529	Set 4 pinzas / Set 4 tweezers	
	62493	Alicate de terminales / Crimping pliers	
1	69504	Magnetizador-desmagnetizador / Magnetizer-demagnetizer	
	65362	Flexómetros / Measuring tape	3m/10'
6	63714, 63715, 63716, 63717, 63718, 63719	Limas de aguja / Needle files	
	65595	Recogedor telescópico / Telescopic joing pick up	
	65586	Espejo articulado / Joint telescopic mirror	
	65774	Regla / Ruler	300 mm
	63119	Cortatubos cobre / Cooper tube cutter	42 mm
1	63172	Cortatubos acero / Steel tube cutter	2"
	63205	Cortatubos plástico Piraina / Piraina plastic pipe cutter	
	69501	Cutter	
	51259	Multímetro digital para automóviles / Automotive digital multimeter	
	69527	Navaja / Penknife	

■ 228 PCS.

■ MM



COD.	PCS.	Medidas en / Sizes in / Mesures en	Kg
68980		-	49
68981	228	51025	99
55775		51074	305

PCS.	Composición / Composition / Composition	Descripción / Description / Description	
16	62214, 62215, 62216, 62217, 62218, 62219, 62220, 62221, 62222, 62223, 62224, 62225, 62226, 62227, 62228, 62229	Alicates Circlips / Circlips pliers	
18	66400, 66401, 66403, 66407, 66408, 76621, 76622, 76624, 76625, 76626, 66439, 66440, 66441, 76629, 76630, 66457, 66458, 66459	Destornilladores mecánicos, electricistas, Philips, Pozidriv® / Slotted, electrician, Philips, Pozidriv® screwdrivers	
13	66474, 66475, 66476, 66477, 66478, 66479, 66480, 66481, 66482, 66483, 66484, 66485, 66486	Destornilladores Torx® / Torx® screwdrivers	
7	66571, 66572, 66573, 66574, 66575, 66576, 66577	Destornilladores T-Mastertork / T-Mastertork screwdrivers	
13	61824, 61825, 61826, 61827, 61828, 61829, 61830, 61831, 61832, 61833, 61834, 61835, 61836	Llaves de tubo doble boca / Socket double ended wrench	
12	61725, 61726, 61727, 61728, 61729, 61730, 61731, 61732, 61733, 61734, 61735, 61736	Llaves combinadas / Combination wrenches	mm
8	61701, 61702, 61703, 61704, 61705, 61706, 61707, 61708	Llaves fijas / Open-end wrenches	
8	61775, 61776, 61777, 61778, 61779, 61780, 61781, 61782	Llaves acodadas / Double offset ring wrenches	
17	61796	Juego llaves vaso / Socket wrench set	1/2", mm
10	61503, 61504, 61505, 61506, 61508, 61509, 61510, 65307, 65308, 65310	Llaves hexagonales / Hexagonal keys	mm
7	63401, 63402, 63403, 63404, 63405, 63406, 63407	Botadores octogonales / Octogonal punches	
6	63435, 63436, 63437, 63438, 63439, 63440	Granetes hexagonales / Hexagonal center punches	
3	63178, 63179, 63180	Cortafíos / Chisel	
6	62332, 62340, 62342, 62343, 62344, 62349	Alicates / Pliers	
1	62135	Tenazas de canal / Box joint pincers	
2	61112	Llave ajustable / Adjustable wrench	
2	62587, 62590	Extractores / Gear pullers	
1	63748	Arco de sierra / Hack Saw	
1	62963	Llave dinamoétrica reversible / Reversible torque wrench	1/2", 40-200 nm

PCS.	Composición / Composition / Composition	Descripción / Description / Description	
7	69619, 69622, 69614, 69750, 69742, 69729, 69521	Martillos / Hammers	
33	66942	Juego puntas / Bits set	
1	61016	Llave HD / HD Pipe wrench	12"
3	62177, 62178, 62172	Tenazas Grip / Grip pincers	
6	63498, 63534, 63570, 63606, 63642, 63678	Limas / Files	
	62233	Tijera de chapa / Tin snip	
	69534	Tijera electricista / Electrician's scissors	
	65479	Calibre / Caliper	
1	65155	Nivel trapezoidal profesional / Professional bridge type spirit level	400 mm
	66731	Destornillador portapuntas magnético / Screwdriver magnetic bitholder	
10	60693	Juego de vasos impacto / Impact socket sets	mm
4	69529	Set 4 pinzas / Set 4 tweezers	
	62493	Alicate de terminales / Crimping pliers	
	69504	Magnetizador-desmagnetizador / Magnetizer-demagnetizer	
	65362	Flexómetros / Measuring tape	3m/10'
	65595	Recogedor telescópico / Telescopic joining pick up	
1	65586	Espejo articulado / Joint telescopic mirror	
	65774	Regla / Ruler	300 mm
	63205	Cortatubos plástico Piraina / Piraina plastic pipe cutter	
	69501	Cutter	
	69527	Navaja / Penknife	

■ 216 PCS.

■ INCH



COD.	PCS.	Medidas en / Sizes in / Mesures en	Kg
68982		-	47
68983	216	51025	97
55776		51074	303

PCS.	Composición / Composition / Composition	Descripción / Description / Description	
16	62214, 62215, 62216, 62217, 62218, 62219, 62220, 62221, 62222, 62223, 62224, 62225, 62226, 62227, 62228, 62229	Alicates Circlips / Circlips pliers	
18	66400, 66401, 66403, 66407, 66408, 76621, 76622, 76624, 76625, 76626, 66439, 66440, 66441, 76629, 76630, 66457, 66458, 66459	Destornilladores mecánicos, electricistas, Philips, Pozidriv® / Slotted, electrician, Philips, Pozidriv® screwdrivers	
13	66474, 66475, 66476, 66477, 66478, 66479, 66480, 66481, 66482, 66483, 66484, 66485, 66486	Destornilladores Torx® / Torx® screwdrivers	
7	66571, 66572, 66573, 66574, 66575, 66576, 66577	Destornilladores T-Mastertork / T-Mastertork screwdrivers	
12	60341, 60342, 60343, 60344, 60345, 60347, 60348, 60349, 60351, 60352, 60353, 60354	Llaves combinadas / Combination wrenches	
8	60302, 60303, 60304, 60306, 60309, 60310, 60311, 60312	Llaves fijas / Open-end wrenches	
17	60382, 60383, 60384, 60385, 60386, 60389, 60390, 60391	Llaves acodadas / Double offset ring wrenches	
10	61798	Juego llaves vaso / Socket wrench set	1/2", inch
10	65318, 65319, 65320, 65321, 65322, 65323, 65324, 65325, 65326, 65327	Llaves hexagonales / Hexagonal keys	inch
7	63401, 63402, 63403, 63404, 63405, 63406, 63407	Botadores octogonales / Octagonal punches	
6	63435, 63436, 63437, 63438, 63439, 63440	Granetes hexagonales / Hexagonal center punches	
3	63178, 63179, 63180	Cortafrios / Chisel	
6	62332, 62340, 62342, 62343, 62344, 62349	Alicates / Pliers	
1	62135	Tenazas de canal / Box joint pincers	
1	61112	Llave ajustable / Adjustable wrench	
2	62587, 62590	Extractores / Gear pullers	
1	63748	Arco de sierra / Hack Saw	
1	62963	Llave dinamométrica / Torque wrench	1/2", 40-200 nm
7	69619, 69622, 69614, 69750, 69742, 69729, 69521	Martillos / Hammers	
33	66942	Juego puntas / Bits set	

PCS.	Composición / Composition / Composition	Descripción / Description / Description	
1	61016	Llave HD / HD Pipe wrench	12"
3	62177, 62178, 62172	Tenazas Grip / Grip pincers	
6	63498, 63534, 63570, 63606, 63642, 63678	Limas / Files	
	62233	Tijera de chapa / Tin snip	
	69534	Tijera electricista / Electrician's scissors	
	65479	Calibre / Caliper	
1	65155	Nivel trapezoidal profesional / Professional bridge type spirit level	400 mm
	66731	Destornillador portapuntas magnético / Screwdriver magnetic bitholder	
11	61267	Juego de vasos impacto / Impact socket sets	
4	69529	Set 4 pinzas / Set 4 tweezers	
	62493	Alicate de terminales / Crimping pliers	
	69504	Magnetizador-desmagnetizador / Magnetizer-demagnetizer	
	65362	Flexómetros / Measuring tape	3m/10'
	65595	Recogedor telescópico / Telescopic joing pick up	
1	65586	Espejo articulado / Joint telescopic mirror	
	65774	Regla / Ruler	300 mm
	63205	Cortatubos plástico Piraina / Piraina plastic pipe cutter	
	69501	Cutter	
	69527	Navaja / Penknife	

■ 109 PCS.

■ MM





COD.	PCS.		Medidas en / Sizes in / Mesures en	
68984		-		27
68985	109	51024	mm	67
55777		50950		122

PCS.	Composición / Composition / Composition	Descripción / Description / Description	
8	62214, 62215, 62216, 62217, 62222, 62223, 62224, 62225	Alicates Circlips / Circlips pliers	
11	66400, 66401, 66403, 66407, 66408, 66439, 66440, 66441, 66457, 66458, 66459	Destornilladores mecánicos, Philips, Pozidriv® / Slotted, Philips, Pozidriv® screwdrivers	-
10	66475, 66476, 66477, 66478, 66479, 66480, 66481, 66482, 66483, 66484	Destornilladores Torx® / Torx® screwdrivers	
12	61725, 61726, 61727, 61728, 61729, 61730, 61731, 61732, 61733, 61734, 61735, 61736	Llaves combinadas / Combination wrenches	mm
8	61701, 61702, 61703, 61704, 61705, 61706, 61707, 61708	Llaves fijas / Open-end wrenches	
	61775, 61776, 61777, 61778, 61779, 61780, 61781, 61782	Llaves acodadas / Double offset ring wrenches	-
17	61796	Juego llaves vaso / Socket wrench set	1/2", mm
10	61503, 61504, 61505, 61506, 61508, 61509, 61510, 65307, 65308, 65310	Llaves hexagonales / Hexagonal keys	mm
3	63402, 63404, 63406	Botadores / Punches	
1	63179	Cortafíos / Chisel	
4	62332, 62343, 62344, 62349	Alicates / Pliers	
	62135	Tenazas de canal / Box joint pincers	
1	61112	Llave ajustable / Adjustable wrench	
2	62587, 62590	Extractores / Gear pullers	
1	62963	Llave dinamométrica reversible / Reversible torque wrench	1/2", 40-200 nm
4	69619, 69622, 69614, 69750	Martillos / Hammers	
1	62178	Tenazas Grip / Grip pincers	
3	63498, 63570, 63678	Limas / Files	
	62233	Tijera de chapa / Tin snip	
1	65362	Flexómetros / Measuring tape	3 m/10'
	65595	Recogedor telescópico / Telescopic joing pick up	
	69501	Cutter	



■ INCH



COD.	PCS.		Medidas en / Sizes in / Mesures en			
68986		-			27	
68987	109	51024	inch		67	
55778		50950		●	122	
PCS.	Composición / Composition / Composition		Descripción / Description / Description			
8	62214, 62215, 62216, 62217, 62222, 62223, 62224, 62225		Alicates Circlips / Circlips pliers			
11	66400, 66401, 66403, 66407, 66408, 66439, 66440, 66441, 66457, 66458, 66459		Destornilladores mecánicos, Philips, Pozidriv® / Slotted, Philips, Pozidriv® screwdrivers			
10	66475, 66476, 66477, 66478, 66479, 66480, 66481, 66482, 66483, 66484		Destornilladores Torx® / Torx® screwdrivers			
12	60341, 60342, 60343, 60344, 60345, 60347, 60348, 60349, 60351, 60352, 60353, 60354		Llaves combinadas / Combination wrenches			
8	60302, 60303, 60304, 60306, 60309, 60310, 60311, 60312		Llaves fijas / Open-end wrenches			inch
	60382, 60383, 60384, 60385, 60386, 60389, 60390, 60391		Llaves acodadas / Double offset ring wrenches			
17	61798		Juego llaves vaso / Socket wrench set			1/2", inch
10	65318, 65319, 65320, 65321, 65322, 65323, 65324, 65325, 65326, 65327		Llaves hexagonales / Hexagonal keys			
3	63402, 63404, 63406		Botadores / Punches			
1	63179		Cortafíos / Chisel			
4	62332, 62343, 62344, 62349		Alicates / Pliers			-
1	62135		Tenazas de canal / Box joint pliers			
	61112		Llave ajustable / Adjustable wrench			
2	62587, 62590		Extractores / Gear pullers			
1	62963		Llave dinamométrica reversible / Reversible torque wrench			1/2", 40-200 nm
4	69619, 69622, 69614, 69750		Martillos / Hammers			
1	62178		Tenazas Grip / Grip pliers			
3	63498, 63570, 63678		Limas / Files			
	62233		Tijera de chapa / Tin snip			
1	65362		Flexómetros / Measuring tape			3 m/10'
	65595		Recogedor telescópico / Telescopic joing pick up			
	69501		Cutter			

■ 53 PCS.



■ MM

COD.	PCS.		Medidas en / Sizes in / Mesures en	
68988		-		8
68989	53	51011	mm	33
PCS.	Composición / Composition / Composition	Descripción / Description / Description		
1	62213	Alicates Circlips / Circlips pliers		
7	66401, 66403, 66407, 66439, 66440, 66457, 66458	Destornilladores mecánicos, electricistas, Philips, Pozidriv® / Slotted, electrician, Philips, Pozidriv® screwdrivers		
12	61725, 61726, 61727, 61728, 61729, 61730, 61731, 61732, 61733, 61734, 61735, 61736	Llaves combinadas / Combination wrenches		
17	61796	Juego llaves vaso / Socket wrench set		
7	61504, 61505, 61506, 61508, 61509, 61510, 65307	Llaves hexagonales / Hexagonal keys		
1	62963	Llave dinamométrica reversible / Reversible torque wrench		
3	62332, 62343, 62344	Alicates / Pliers		
1	62135	Tenazas de canal / Box joint pincers		
2	69622, 69614	Martillos / Hammers		
1	69534	Tijera electricista / Electrician 's scissors		





■ 57 PCS.

■ INCH

COD.	PCS.		Medidas en / Sizes in / Mesures en	
68990		-		9
68991	57	51011	inch	34
PCS.	Composición / Composition / Composition	Descripción / Description / Description		
1	62213	Alicates Circlips / Circlips pliers		
11	66400, 66401, 66403, 66407, 66408, 66439, 66440, 66441, 66457, 66458, 66459	Destornilladores mecánicos, electricistas, Philips, Pozidriv® / Slotted, electrician, Philips, Pozidriv® screwdrivers		
12	60341, 60342, 60343, 60344, 60345, 60347, 60348, 60349, 60351, 60352, 60353, 60354	Llaves combinadas / Combination wrenches		
17	61798	Juego llaves vaso / Socket wrench set		
7	65320, 65321, 65322, 65323, 65324, 65325, 65326	Llaves hexagonales / Hexagonal keys		
1	62963	Llave dinamométrica reversible / Reversible torque wrench		
3	62332, 62343, 62344	Alicates / Pliers		
1	62135	Tenazas de canal / Box joint pincers		
2	69622, 69614	Martillos / Hammers		
1	69534	Tijera electricista / Electrician 's scissors		





26 PCS.

COD.	PCS.		
69538	26	51013	4,5
PCS.	COD.	Descripción / Description / Description	
1	61112	Llave ajustable Unique Plus Titacrom® / Unique Plus Titacrom® Adjustable wrench	10"
	62479	Alicate universal Mastercut / Mastercut Combination pliers	210 mm
	62499	Alicate telefonista Mastercut / Mastercut Long nose pliers	200 mm
	62343	Alicate corte diagonal / Diagonal cutting plier	160 mm
10	61496	Set Allen punta bola / Long patern ballpoint Allen set	-
	66401		4x100
	66403	Destornillador mecánico / Slotted screwdriver	5,5x125
	66405		6,5x150
	66406		8x150
	66439	Destornillador Philips / Philips screwdriver	PH1
	66440		PH2
1	66457	Destornillador Pozidriv® / Screwdriver Pozidriv®	PZ1
	66458		PZ2
	69613	Martillo de bola / Ball pein hammer	425 g
	63326	Cinzel / Flat chisel	23x200
	63748	Arco de Sierra / Hack Saw	-
	62850	Cortafíos / Chisel	20x200





26 PCS.

COD.	PCS.		
51620	26	51010	6,9
PCS.	COD.	Descripción / Description / Description	
	62450	Alicate universal bimat / Combination plier bimat	
	62455	Alicate telefonista Titacrom® / Long nose plier titacrom® bimat	160 mm
	62459	Alicate corte diagonal bimat / Diagonal cutting plier bimat	
	62411	Tenaza pico loro automática / Auto grip groove joint plier	8"
1	61229	Llave ajustable de gran apertura Titacrom® / Wide opening adjustable wrench Titacrom®	6"
	66886		3x60
	66888	Destornillador electricista Rotork / Electrician screwdriver Rotork	4x125
	66890		5x150
	66898	Destornillador philips Rotork / Screwdriver philips Rotork	PH-1
	66908	Destornillador pozidriv Rotork / Screwdriver pozidriv Rotork	PZ-1
10	61500	Juego 10 llaves allen / Set of 10 hexagonal key wrenches	1,5-10
	65172	Flexómetro Rallye II / Rallye II Measuring tape	3M/16MM
	66909	Destornillador pozidriv Rotork / Screwdriver pozidriv Rotork	PZ-2
1	66899	Destornillador philips Rotork / Screwdriver philips Rotork	PH-2
	69614	Martillo bola madera / Ball pein hammer	
	61405	Llave mastergrip / Mastergrip wrench	10"
	69534	Tijera electricista / Electrician scissors	145 mm





135 PCS.

COD.	PCS.		
69396	135	51011	60
PCS.	Composición / Composition / Composition	Descripción / Description / Description	
25	61960	Juego / Set	1/2", 25 pcs
	69280	Juego llaves combinadas / Combination wrenches set	26 pcs
26	61870, 61871, 61872, 61873, 61874, 61875, 61876, 61877, 61878, 61879, 61880, 61881, 61882, 61883, 61884, 61885, 61886, 61887, 61888, 61889, 61890, 61891, 61892, 61893, 61894, 61895	Llaves de pipa / Angled sockets	6-32
10	61500	Juego llaves Allen / Allen keys wrenches Set	1,5/2/2,5/3/4/5/5,5/6/8/10, hex.
	61110	Llave ajustable Unique Plus / Unique Plus adjustable wrench	6"
1	61935	Llave ajustable Alavesa Combi Unique Plus / Basque Combi Unique Plus adjustable wrench	12"
5	66877, 66878, 66879, 66881, 66882	Destornilladores mecánico	
	66898, 66899, 66900	Destornilladores Philips Rotork / Philips Rotork screwdrivers	
3	66908, 66909, 66910	Destornilladores Pozidriv® / Pozidriv® screwdrivers	
	66921, 66923, 66926	Destornilladores Torx® Rotork / Rotork Torx® screwdrivers	
	62332	Alicate universal Titacrom® / Titacrom® Combination pliers	
	62340	Alicate telefonista Titacrom® / Titacrom® Long nose pliers pliers	
	62342	Alicate telefonista b/curva / Titacrom® bent nose pliers	
	62344	Cortaalambreres reforzado / Heavy Duty cutting nippers	
	62129	Tenaza canal / Box joint plier	
1	62172	Tenaza Grip curva / Curved Grip pliers	
	62349	Alicate pelacables / Wirestripper	
	62216	Alicate Circlips exterior recto / External straight Circlips pliers	
	62220	Alicate Circlips exterior curvo / External bent Circlips pliers	
	62224	Alicate Circlips interior recto / Internal straight Circlips pliers	
	62228	Alicate Circlips interior curvo / Internal bent Circlips pliers	
	63748	Arco de sierra / Hack Saw	
10	64435	Hojas de sierra acero al carbono / Carbon steel hacksaw blade	24 dientes / 24 teeth
	69621	Martillo alemán / German type machinist's hammer	
	69616	Martillo de bola / Ball pein hammer	
	55326	Martillo de nylon / Nylon hammer	
	61017	Llave Heavy Duty / Heavy Duty pipe wrench	14"
1	61035	Llave de cadena reversible / Reversible chain pipe wrench	
	61480	Llave de correa / Strap wrench	
	63119	Cortatubos Unique / Unique tube cutter	42 mm
	68003	Abocinador / Pulg flaring tool	
	62151	Tenaza cortacables / Cable cutters	
	69501	Cutter	





104 PCS.

COD.	PCS.		
69398	104	51012	17
PCS.	Composición / Composition / Composition	Descripción / Description / Description	
25	61960	Juego / Set	1/2", 25 pcs
	69795	Juego llaves fijas / Open end wrenches set	12 pcs
12	69278	Juego llaves combinadas / Combination wrenches set	6/7/8/9/10/11/12/13/14/15/16/17
10	61500	Juego llaves Allen / Allen keys wrenches Set	1,5/2/2,5/3/4/5/5,5/6/8/10, hex.
2	61110, 61113	Llaves ajustables Unique / Unique adjustable wrenches	6"/12"
5	66877, 66878, 66879, 66881, 66882	Destornilladores mecánico Rotork / Rotork slotted screwdriver	
	66898, 66899, 66900	Destornilladores Philips Rotork / Philips Rotork screwdrivers	
	66908, 66909, 66910	Destornilladores Pozidriv® Rotork / Pozidriv® Rotork screwdrivers	
3	66921, 66923, 66926	Destornilladores Torx® Rotork / Rotork Torx® screwdrivers	
	66937, 66938, 66939	Destornilladores carroceros Rotork / Rotork Stubby screwdrivers	
	62332	Alicate universal Titacrom® Bimat / Titacrom® Bimat combination pliers	
	62337	Alicate b/plana Titacrom® Bimat / Titacrom® Bimat flat nose pliers	
	62338	Alicate b/redonda Titacrom® Bimat / Titacrom® Bimat round nose pliers	
	62341	Alicate telefonista b/curva Titacrom® Bimat / Titacrom® Bimat bent nose pliers	
	62343	Alicate c/diagonal Titacrom® Bimat / Titacrom® Bimat cutting pliers	
1	62445	Tenaza Pico Loro Bimat / Bimat groove joint	
	62231	Tenaza Grip recta / Straight grip pliers	
	62183	Alicate Circlips exterior recto / External straight Circlips pliers	
	62182	Alicate Circlips exterior curvo / External bent Circlips pliers	
	62181	Alicate Circlips interior recto / Internal straight Circlips pliers	
	62180	Alicate Circlips interior curvo / Internal bent Circlips pliers	
	63748	Arco de sierra / Hack Saw	
10	64435	Hojas de sierra acero al carbono / Carbon steel hacksaw blade	24 TPI
1	69604	Martillo ebanista / Joiners hammer	
	55326	Martillo de nylon / Nylon hammer	



■ 47 PCS.



■ MM

COD.	PCS.	Medidas en / Sizes in / Mesures en		
68992			16	-
68993	47	mm	41	51011
PCS.	Composición / Composition / Composition	Descripción / Description / Description		
12	69251	Juego llaves fijas / Open end wrenches set	6x7 - 8x9 - 10x11 - 12x13 - 14x15 - 16x17 - 18x19 - 20x22 - 21x23 - 24x27 - 25x28 - 30x32 mm	
2	63178, 63179	Cortafíos / Chisel	160-200	
	61112	Llave ajustable / Adjustable wrench	10"	
	63172	Cortatubos acero / Steel tube cutter	2"	
	63119	Cortatubos de cobre Unique / Unique 42 copper	-	
	61004	Llave Stillson / Stillson pipe wrench	14"	
	61465	Llave Blitz / Blitz Wrench	175	
1	62133	Tenaza de canal / Box joint	10"	
	62233	Tijera para chapa / Tin snip	12"	
	62172	Tenaza Grip boca curva / Curved jaw grip plier	10"	
	69534	Tijera electricista / Electrician's scissors		
	62333	Alicate universal Titacrom® / Titacrom® Combination pliers	180	
5	66400, 66401, 66403, 66405, 66407	Destornilladores Mastertork / Mastertork Screwdrivers	3x80 - 4x100 - 5,5x125 - 6,5x150 - 8x200	
2	66439, 66440		PH1 - PH2	
	69619	Martillo mecánico alemán / German type machinist's hammer	300 g	
	65172	Flexómetro Rallye II / Rallye II Measuring tape	3 m / 16 mm	
	63570	Lima media caña entrefina / Medium half round file	8"	
1	63678	Lima redonda entrefina / Medium round file		
	65293	Nivel trapezoidal profesional / Professional bridge type spirit level	400 mm	
	63748	Arco de sierra / Hack Saw	-	
	68003	Abocinador / Pulg flaring tool	mm	
	61480	Llave de correa / Strap wrench	450 mm	
8	68172	Set curvatubos carraca / Ratchet tube bender set	mm	





**JUEGOS FONTANERÍA Y AIRE ACONDICIONADO / PLUMBING AND CONDITIONED AIR SETS / SETS PLOMBERIE ET AIR CONDITIONNEE / WERKZEUG SETS
FÜR KLEMPNER UND KLIMATECHNIK / KIT PER IDRAULICA E CONDIZIONAMENTO / JOGOS DE CANALIZAÇÃO E AR CONDICIONADO / НАБОРЫ ДЛЯ
КОНДИЦИОНИРОВАНИЯ И ДЛЯ САНТЕХНИКИ**

114 PCS.

COD.	PCS.		
69393	114	51012	19,5
PCS.	Composición / Composition / Composition	Descripción / Description / Description	
12	69795	Juego llaves fijas / Open end wrenches set	12 pcs
10	69256	Juego llaves acodadas / Double offset wrenches set	10 pcs
1	61113	Llave Ajustable Unique Titacrom® / Unique Titacrom® adjustable wrench	12"
29	61958	Juego / Set	1/4", 29 pcs
2	61305, 61306	Llaves de vaso de doble articulación / Double ended swivel	16-17/18-19
10	61500	Juego llaves Allen / Allen keys wrenches Set	1,5/2/2,5/3/4/5/5,5/6/8/10, hex.
5	66874, 66876, 66878, 66880, 66881	Destornilladores mecánicos Rotork / Rotork slotted screwdrivers	
	76651, 76653, 76654	Destornilladores varilla protegida Rotork / Rotork Insulated screwdrivers	
3	76655, 76656, 76657	Destornilladores varilla protegida Philips Rotork / Rotork Philips insulated screwdrivers	
	76659, 76660, 76661	Destornilladores varilla protegida Pozidriv® Rotork / Rotork Pozidriv® insulated screwdrivers	
4	66920, 66921, 66922, 66923	Destornilladores Torx® Microtronic / Torx® Microtronic screwdrivers	
3	66937, 66938, 66939	Destornilladores carroceros Rotork / Rotork Stubby screwdrivers	
	66071	Destornillador buscapolos / Voltage tester screwdriver	
1	61011	Llave sueca / Swedish pipe wrench	S-45°
	61035	Llave de cadena reversible / Reversible chain pipe wrench	-
	63105	Cortatubos Telescopic / Telescopic tube cutter	32
6	68052	Kit frigorifista / Refrigeration Kit	
1	63748	Arco de sierra / Hack Saw	
10	64435	Hojas de sierra acero al carbono / Carbon steel hacksaw blade	
	69501	Cutter	
	69604	Martillo ebanista / Joiners hammer	
	62332	Alicate universal Titacrom® Bimat / Titacrom® Bimat combination pliers	
	62342	Alicate telefonista b/curva Titacrom® Bimat / Titacrom® Bimat bent nose pliers	
1	62344	Alicate cortaalambres Titacrom® Bimat Heavy Duty / Titacrom® Bimat, Heavy Duty cutting knippers	
	62349	Alicate pelacables Bimat / Bimat wirestripper pliers	
	62297	Tenaza canal Bimat Box / Bimat Box joint pliers	
	62178	Tenaza Grip Curva / Curved Grip pliers	





68 PCS.

COD.	PCS.		
69397	68	51012	19
PCS.	Composición / Composition / Composition	Descripción / Description / Description	
12	69795	Juego llaves Fijas / Open end wrenches set	12 pcs
	61935	Llave Combi Alavesa ajustable / Basque adjustable wrench combi	12"
1	61004	Llave Stillson / Stillson pipe wrench	14"
	61041	Llave Sueca / Swedish pipe wrench	45°, 1"
	61035	Llave de cadena reversible / Reversible chain pipe wrench	
10	61500	Juego llaves Allen / Allen keys wrenches Set	1,5/2/2,5/3/4/5/5,5/6/8/10, hex.
1	61009	Llave de lavabo / Basin Wrench	
5	66875, 66877, 66879, 66881, 66882	Destornilladores mecánico Rotork / Rotork slotted screwdriver	
3	66898, 66899, 66900	Destornilladores Philips Rotork / Philips Rotork screwdrivers	
2	66909, 66910	Destornilladores Pozidriv® Rotork / Pozidriv® Rotork screwdrivers	
4	66921, 66923, 66926, 66927	Destornilladores Torx® Rotork / Rotork Torx® screwdrivers	
	62333	Alicate universal Titacrom® Bimat / Titacrom® Bimat combination pliers	
	62344	Alicate cortaalambres Titacrom® Bimat Heavy Duty Knippers / Titacrom® Bimat Heavy Duty Knippers cutting pliers	
	62172	Tenaza Grip Curva / Curved Grip pliers	
	62294	Tenaza canal Titacrom® Box / Titacrom® Box Joint pliers	
	62123	Tenaza rusa Titacrom® / Titacrom® Tower pincer	
	63170	Cortatubos Classic / Classic Tube cutter	32
	63171	Cortatubos acero / Steel tube cutter	1 1/4"
1	63200	Tijera para tubo de plástico / Plastic pipe cutter	
	62159	Tijera cortachapa / Tin Snip	
	63748	Arco de Sierra / Hack Saw	
	64435	Hojas de sierra acero al carbono / Carbon steel hacksaw blade	24 dientes / 24 teeth
	69620	Martillo alemán / German type machinist's hammer	
1	69605	Maceta / Stoning hammer	
	68003	Abocinador / Pulg flaring tool	
	69505	Desatascador de muelle / Spring pipe cleaner	
3	68043, 68045, 68054	Muelles curvatubos / Sping tube benders	10-14-18



24 PCS.

COD.	PCS.		
69537	24	51013	8,0
PCS.	COD.	Descripción / Description / Description	
1	61934	Llave ajustable Alavesa combi / Basque Combi adjustable wrench	
	61017	Llave Heavy Duty / Heavy Duty pipe wrench	
	63172	Cortatubos acero / Steel tube cutter	
	62479	Alicate universal Mastercut / Mastercut Combination pliers	
	62499	Alicate telefonista Mastercut / Mastercut Long nose pliers	
	62343	Alicate corte diagonal / Diagonal cutting plier	
10	61496	Set Allen punta bola / Long pattern ballpoint Allen set	
	66401	-	
	66403	4x100	
	66405	Destornillador mecánico / Slotted screwdriver	
	66406	5,5x125	
	66406	6,5x150	
	66406	8x150	
1	66439	Destornillador Philips / Philips screwdriver	
	66440	PH1	
	66440	PH2	
	63119	Cortatubos Unique / Unique tube cutter	
	63748	Arco de Sierra / Hack Saw	
		-	

JUEGOS ELECTRICIDAD / ELECTRICIAN SETS / SETS ÉLECTRICIENS / WERKZEUGSÄTZE FÜR ELEKTRIZITÄT / KIT ELETTRICISTI / JOGOS ÉTRICIDADE / НАБОР ЭЛЕКТРИКА

5 PCS.



MM

COD.	PCS.		Medidas en / Sizes in / Mesures en	
79060	5	51033	mm	1,2
PCS.	Composición / Composition / Composition		Descripción / Description / Description	
4	76583, 76594, 76603, 76595		Alicates / Pliers	
1	73004		Tenaza de canal / Box joint	





10 PCS.

MM

COD.	PCS.		Medidas en / Sizes in / Mesures en	
79061	10	51033	mm	3
PCS.	Composición / Composition / Composition		Descripción / Description / Description	
4	76583, 76594, 76603, 76595		Alicates / Pliers	
3	76621, 76623, 76626		Destornilladores electricistas / Electrician screwdrivers	
2	76634, 76635		Destornilladores Pozidriv® / Pozidriv® screwdrivers	
1	73004		Tenaza de canal / Box joint	





COD.	PCS.		Medidas en / Sizes in / Mesures en	
79062	10	51033	mm	2,5
PCS.	Composición / Composition / Composition		Descripción / Description / Description	
4	76583, 76603, 76590, 76599		Alicates / Pliers	
1	66072		Tester	
4	76621, 76622, 76623, 76625		Destornilladores electricistas / Electrician screwdrivers	
1	76629		Destornilladores Philips / Philips screwdriver	



17 PCS.



MM

COD.	PCS.		Medidas en / Sizes in / Mesures en	
79063	17	51033	mm	3,6
PCS.	Composición / Composition / Composition		Descripción / Description / Description	
6	76584, 76599, 76592, 76603, 76589, 76590		Alicates / Pliers	1000V
1	66072		Tester	-
6	76620, 76621, 76623, 76625, 76626, 76627		Destornilladores electricistas / Electrician screwdrivers	
2	76629, 76630		Destornilladores Philips / Philips screwdriver	1000V
	73035, 73036		Cuchillos / Knives	



26 PCS.



MM

COD.	PCS.		Medidas en / Sizes in / Mesures en	
79064	26	51033	mm	5
PCS.	Composición / Composition / Composition		Descripción / Description / Description	
7	76583, 76603, 76592, 76594, 76595, 76590, 76589		Alicates / Pliers	
2	73156, 73158		Llaves hexagonales / Hexagonal keys	
5	76621, 76622, 76623, 76625, 76626		Destornilladores electricistas / Electrician screwdrivers	
2	76629, 76630		Destornilladores Philips / Philips screwdriver	1000V
	76634, 76635		Destornilladores Pozidriv® / Pozidriv® screwdrivers	
4	74700, 74701, 74702, 74703		Destornilladores de vaso / Socket screwdriver	
2	73035, 73036		Cuchillos / Knives	
	73008		Cortacables / Cable cutters	
1	66072		Tester	-



27 PCS.



INCH

COD.	PCS.		Medidas en / Sizes in / Mesures en	
79065	27	51054	inch	8
PCS.	Composición / Composition / Composition		Descripción / Description / Description	
3	76583, 76597, 76592		Alicates / Pliers	
	76621, 76623, 76625		Destornilladores electricistas / Electrician screwdrivers	1000V
2	76629, 76630		Destornilladores Philips / Philips screwdriver	
1	73685		Carraca / Ratchet	-
2	73280, 73281		Alargadera / Extension	3/8" - 1000V
8	75162, 75163, 75164, 75165, 75167, 75168, 75169, 75170		Vasos / Sockets	
	73349, 73350, 73351, 73352, 73353, 73354, 73355, 73356		Llaves de estrella acodada una boca / Offset ring wrenches	1000V





37 PCS.

MM

COD.	PCS.		Medidas en / Sizes in / Mesures en	
79066	37	51054	mm	9
PCS.	Composición / Composition / Composition		Descripción / Description / Description	
4	76583, 76603, 76592, 76599		Alicates / Pliers	
1	73008		Cortacables / Cable cutters	
6	73064, 73067, 73068, 73071, 73073, 73076		Llaves fijas una boca / Single ended open jaw spanner	1000V
	73122, 73125, 73126, 73129, 73131, 73134		Llaves de estrella / Ring wrenches	
1	73683		Carraca / Ratchet	
2	73446, 73445		Alargadera / Extension	3/8" - 1000V
1	73448		Mango en T / T Handle	1000V
9	74962, 74963, 74964, 74965, 74966, 74969, 74971, 74974, 74976		Vasos / Sockets	1/2" - 1000V
2	73035, 73036		Cuchillos / Knives	
1	73040		Pinza de plástico / Plastic tweezers	1000V
4	76621, 76622, 76623, 76625		Destornilladores electricistas / Electrician screwdrivers	1000V





MM

COD.	PCS.		Medidas en / Sizes in / Mesures en	
76688		-		3,0
76689	37	51010	mm	7,0
PCS.	Composición / Composition / Composition	Descripción / Description / Description		
5	76584, 76591, 76593, 76595, 76603	Alicates / Pliers		
	73008	Tenaza cortacables / Cable cutters		
1	73040	Pinzas / Tweezers		1000V
	73035	Cuchillos / Knives		
	73005	Tenazas de canal / Box joint pincers		
5	73064, 73065, 73067, 73068, 73070	Llaves fijas una boca / Single ended open jaw spanner		
1	69534	Tijera electricista / Electrician's scissors		
	51257	Tester		-
5	76621, 76622, 76624, 76625, 76626	Destornilladores electricistas / Electrician screwdrivers		1000V
3	76629, 76630, 76631	Destornilladores Philips / Philips screwdriver		
	63254	Soldador de estaño / Tin soldering iron		
1	63256	Succionador con boquilla antiestática para soldadura / Desoldering pump with anti-static rubber nozzle		-
6	73232, 73233, 73234, 73236, 73238, 73239	Vasos / Sockets		1000V
1	73245	Alargadera / Extension		
	73246	Carraca / Ratchet		



52 PCS.

MM

COD.	PCS.		Medidas en / Sizes in / Mesures en	
76686		-		6,0
76687	52	51011	mm	31
PCS.	Composición / Composition / Composition	Descripción / Description / Description		
8	76584, 76590, 76592, 76591, 76593, 76594, 76595, 76603	Alicates / Pliers		
1	73008	Tenaza cortacables / Cable cutters		
2	73040, 73041	Pinzas / Tweezers		
	73035, 73036	Cuchillos / Knives		
	73011	Cortacables de carraca / Ratchet electrician cable cutter		1000V
1	73005	Tenazas de canal / Box joint pincers		
	76552	Llave ajustable / Adjustable wrench		
8	73064, 73065, 73066, 73067, 73068, 73071, 73073, 73076	Llaves fijas una boca / Single ended open jaw spanner		
1	69534	Tijera electricista / Electrician's scissors		
1	62494	Alicata para terminales / Terminals plier		-
	51257	Tester		
6	76621, 76622, 76624, 76625, 76626, 76627	Destornilladores electricistas / Electrician screwdrivers		1000V
5	76628, 76629, 76630, 76631, 76632	Destornilladores Philips / Philips screwdriver		
	63254	Soldador de estaño / Tin soldering iron		
1	63256	Succionador con boquilla antiestática para soldadura / Desoldering pump with anti-static rubber nozzle		-
	65587	Espejo articulado / Joint telescopic mirror		
6	73232, 73233, 73234, 73236, 73238, 73239	Vasos / Sockets		1000V
1	73245	Alargadera / Extension		
	73687	Carraca / Ratchet		
3	73251, 73252, 73253	Boquillas hexagonales / Hexagonal sockets		



■ 16 PCS.

■ MM

COD.	PCS.		Medidas en / Sizes in / Mesures en	
76690		-		2,0
76691	16	51013	mm	4,0

PCS.	Composición / Composition / Composition	Descripción / Description / Description	
3	76584, 76591, 76595	Alicates / Pliers	
1	73040	Pinzas / Tweezers	1000V
	73035	Cuchillos / Knives	
3	73064, 73067, 73070	Llaves fijas una boca / Single ended open jaw spanner	
1	69534	Tijera electricista / Electrician's scissors	-
	66071	Buscapolos / Voltage tester	
4	76621, 76622, 76625, 76626	Destornilladores electricistas / Electrician screwdrivers	1000V
2	76629, 76630	Destornilladores Philips / Philips screwdriver	





■ 20 PCS.

COD.	PCS.		
69536	20	51013	4,0

PCS.	COD.	Descripción / Description / Description	
	76609	Alicates universales Mastercut / Mastercut combination pliers	1000V, 210 mm
	76595	Alicate corte diagonal / Diagonal cutting plier	
	76591	Alicates telefonista recto / Long nose pliers	1000V, 160 mm
	76603	Alicate pelacables / Wirestripper	
	62494	Alicate para terminales / Terminals plier	220 mm
	76622	Destornillador electricista / Electrician screwdriver	1000V, 4x125
	76625		1000V, 6,5x150
	76629	Destornillador Philips / Philips screwdriver	1000V, PH1
	76630		1000V, PH2
1	66422		3 x 100
	66423		4 x 125
	66425	Destornillador electricista / Electrician screwdriver	5,5 x 150
	66426		6,5 x 150
	66427		8 x 175
	66072	Buscapolos / Voltage tester	150 mm
	73035	Cuchillo / Knife	1000V
	69662	Maceta modelo español / Spanish type stoning hammer	1000 g
	69534	Tijera electricista / Electrician's scissors	145 mm
	65167	Flexómetro robust magnet / Robust Magnet Measuring tape	5 x 25
	63748	Arco de sierra / Hack Saw	-





99 PCS.

COD.	PCS.		
69390	99	51010	8,0
PCS.	Composición / Composition / Composition	Descripción / Description / Description	
29	61958	Juego / Set	1/4", 29 pcs
6	69248	Juego de llaves fijas / Open end wrenches set	6-7/8-9/10-11/12-13/14-15/16-17
1	61110	Llave ajustable Unique Plus Titacrom® / Unique Plus Titacrom® Adjustable wrench	6"
4	66846, 66847, 66848, 66849	Destornilladores boca plana Microtronic / Microtronic flat nose screwdrivers	
3	66850, 66851, 66852	Destornilladores Philips Microtronic / Philips Microtronic screwdrivers	
2	66853, 66854	Destornilladores Pozidriv® Microtronic / Pozidriv® Microtronic screwdrivers	
5	66855, 66856, 66857, 66858, 66859	Destornilladores Torx® Microtronic / Torx® Microtronic screwdrivers	
4	66862, 66863, 66864, 66865	Destornilladores hexagonales Microtronic / Microtronic hexagonal screwdrivers	
3	76651, 76652, 76653	Destornilladores varilla protegida Rotork / Rotork Insulated screwdrivers	
2	76655, 76656	Destornilladores varilla protegida Philips Rotork / Rotork Philips insulated screwdrivers	1000V
	76659, 76660	Destornilladores varilla protegida Pozidriv® Rotork / Rotork Pozidriv® insulated screwdrivers	
3	66928, 66929, 66930	Destornilladores punta esfera Rotork Philips / Rotork Philips ball tip screwdrivers	
	66917, 66918, 66919	Destornilladores Torx® Rotork / Rotork Torx® screwdrivers	
1	66070	Destornillador buscapolos / Voltage tester screwdriver	
8	61499	Juego llaves Allen / Allen keys wrenches Set	1,5/2/2,5/3/4/5/5,5/6, hex.
5	61870, 61871, 61872, 61873, 61874	Llaves de pipa / Angled sockets	6/7/8/9/10
4	61824, 61825, 61826, 61827	Llaves de tubo doble boca / Socket double ended wrench	6,7/8-9/10-11-12-13
1	62241	Alicate mini universal Titacrom® Bimat / Titacrom® Bimat combination electronic pliers	
	62242	Alicate mini b/plana Titacrom® Bimat / Titacrom® Bimat flat nose electronic pliers	
	62243	Alicate mini b/redonda Titacrom® Bimat / Titacrom® Bimat round nose electronic pliers	
	62244	Alicate mini telefonista Titacrom® Bimat / Titacrom® Bimat long nose electronic pliers	
	62245	Alicate mini b/curva Titacrom® Bimat / Titacrom® Bimat bent nose electronic pliers	
	62246	Alicate mini b/aguja Titacrom® Bimat / itacrom Bimat long needle nose electronic pliers	
	62247	Alicate mini c/diagonal Titacrom® Bimat / Titacrom® Bimat diagonal cutting wlectronic pliers	
	62249	Alicate mini c/frontal Titacrom® Bimat / Titacrom® Bimat end cutter electronic pliers	
4	69529	Set 4 pinzas / Set 4 tweezers	
1	69501	Cutter	
1	69601	Martillo ebanista / Joiners hammer	



84 PCS.



COD.	PCS.		
69391	84	51010	11
PCS.	Composición / Composition / Composition	Descripción / Description / Description	
29	61958	Juego / Set	1/4", 29 pcs
8	69249	Juego de llaves fijas / Open end wrenches set	6-7/8-9/10-11/12-13/14-15/16-17/18-19/20-22
10	61615, 61616, 61617, 61618, 61619, 61620, 61621, 61622, 61623, 61624	Llaves Allen p/bola / Keys Wrenches	1,5/2/2,5/3/4/5/5,5/6/8/10, hex.
	76651, 76652, 76653, 76654	Destornilladores varilla protegida Rotork / Rotork Insulated screwdrivers	
4	76655, 76656, 76657, 76658	Destornilladores varilla protegida Philips Rotork / Rotork Philips insulated screwdrivers	1000V
	76659, 76660, 76661, 76662	Destornilladores varilla protegida Pozidriv® Rotork / Rotork Pozidriv® insulated screwdrivers	
	66070	Destornillador buscapolos / Voltage tester screwdriver	-
	76552	Llave ajustable Titacrom® / Titacrom® Adjustable wrench	10", 1000V
	76584	Alicate universal / Combination pliers	
	76589	Alicate b/plana / Flat nose pliers	
	76590	Alicate b/redonda / Round nose pliers	
	76591	Alicate telefonista / Long nose plier	
1	76593	Alicate telefonista b/curva / Titacrom® bent nose pliers	1000V
	76595	Alicate c/diagonal / Diagonal cutting pliers	
	76603	Alicate pelacables / Wirestripper	
	62445	Tenaza Pico Loro Bimat / Bimat groove joint	-
	62178	Tenaza Grip / Grip plier	7"
	62151	Tenaza cortacables / Cable cutters	
	69501	Cutter	-
	63748	Arco de sierra / Hack saw	
10	64435	Hojas de sierra acero al carbono / Carbon steel hacksaw blade	24 dientes / 24 teeth
1	69603	Martillo ebanista / Joiners hammer	-



EGGA Master

ART IN INNOVATION



ELECTROMECÁNICA / ELECTROMECHANICAL KIT / KIT ELECTROMÉCANIQUE / WERKZEUGSET FÜR ELEKTROMECHANIK / ELETTRMECCANICA / ELECTROMECÂNICA / ЭЛЕКТРОМЕХАНИЧЕСКИЙ НАБОР
102 PCS.

COD.	PCS.		
69392	102	51010	10
PCS.	Composición / Composition / Composition	Descripción / Description / Description	
29	61958	Juego / Set	1/4", 29 pcs
10	69277	Juego llaves combinadas / Combination wrenches set	10 pcs
1	61908	Llave ajustable Unique Plus Titacrom® Comfort / Unique Plus Titacrom® Comfort adjustable wrench	10"
4	76651, 76652, 76653, 76654	Destornilladores varilla protegida Rotork / Rotork Insulated screwdrivers	
	76655, 76656, 76657	Destornilladores varilla protegida Philips Rotork / Rotork Philips insulated screwdrivers	
3	76659, 76660, 76661	Destornilladores varilla protegida Pozidriv® Rotork / Rotork Pozidriv® insulated screwdrivers	
	66928, 66929, 66930, 66931, 66932	Destornilladores punta esfera Rotork / Rotork ball tip screwdrivers	
5	66917, 66918, 66919, 66920, 66921	Destornilladores Torx® Rotork / Rotork Torx® screwdrivers	
2	66934, 66935	Destornilladores Robertson Rotork / Rotork Robertson screwdrivers	
1	66071	Destornillador buscapolos / Voltage tester screwdriver	
5	61824, 61825, 61826, 61827, 61828	Llaves de tubo doble boca / Socket double ended wrench	6-7/8-9-10-11/12-13/14-15
8	61499	Juego llaves Allen / Allen keys wrenches Set	1,5/2/2,5/3/4/5/5,5/6, hex.
	62177	Tenaza Grip curva / Curved Grip pliers	
	62331	Alicate universal Titacrom® Bimat / Titacrom® Bimat combination pliers	
	62337	Alicate b/plana Titacrom® Bimat / Titacrom® Bimat flat nose pliers	
	62339	Alicate telefonista Titacrom® Bimat / Titacrom® Bimat long nose pliers	
	62341	Alicate telefonista b/curva Titacrom® Bimat / Titacrom® Bimat bent nose pliers	
	62343	Alicate corte diagonal Titacrom® Bimat / Titacrom® Bimat diagonal cutting pliers	
	62349	Alicate pelacables Titacrom® Bimat / Titacrom® Bimat wirestripper	
1	62445	Tenaza Pico Loro Bimat / Bimat groove joint	
	62214	Alicate Circlips exterior recto / External straight Circlips pliers	
	62218	Alicate Circlips exterior curvo / External bent Circlips pliers	
	62222	Alicate Circlips interior recto / Internal straight Circlips pliers	
	62226	Alicate Circlips interior curvo / Internal bent Circlips pliers	
	69603	Martillo ebanista / Joiners hammer	
	69531	Pinza / Tweezers	45°
	69533	Pinza b/plana / Flat nose tweezers	
	69532	Pinza autoapretante / Self adjusting tweezers	
8	69433	Kit	8 pcs
1	69504	Magnetizador / Magnetizer	
	69501	Cutter	



MANTENIMIENTO DE EDIFICIOS / BUILDING MAINTENANCE / KIT POUR L'ENTRETIEN DE BÂTIMENT / WERKZEUGSATZ FÜR GEBÄUDEWARTUNG / EDILIZIA INDUSTRIALE / MANUTENÇÃO DE EDIFÍCIOS / НАБОР ДЛЯ ОБСЛУЖИВАНИЯ ЗДАНИЙ



73 PCS.

COD.	PCS.		
69395	73	51012	20
PCS.	Composición / Composition / Composition	Descripción / Description / Description	
8	69249	Juego de llaves fijas / Open end wrenches set	8 pcs
1	61113	Llave ajustable Unique Plus Titacrom® / Unique Plus Titacrom® Adjustable wrench	1/2"
8	61824, 61825, 61826, 61827, 61828, 61829, 61830, 61831	Llaves de tubo doble boca / Socket double ended wrench	-
10	61500	Juego llaves Allen / Allen keys wrenches Set	1,5/2/2,5/3/4/5/5,5/6/8/10, hex.
	62332	Alicate universal Titacrom® Bimat / Titacrom® Bimat combination pliers	
	62344	Alicate cortaalambres Titacrom® Bimat Heavy Duty / Titacrom® Bimat, Heavy Duty cutting knippers	
1	62297	Tenaza canal Bimat / Bimat box joint pliers	
	62172	Tenaza Grip curva / Curved Grip pliers	
	62349	Alicate pelacables Titacrom® Bimat / Titacrom® Bimat wirestripper	
	62124	Tenaza rusa Titacrom® / Titacrom® Tower pincer	
	61005	Llave Stillson / Stillson pipe wrench	18"
	63748	Arco de Sierra / Hack Saw	-
10	64435	Hojas de sierra acero al carbono / Carbon steel hacksaw blade	24 dientes / 24 teeth
	62159	Tijera cortachapa / Tin Snip	
	69501	Cutter	
	62151	Tenaza cortacables / Cable cutters	
1	69614	Martillo de bola / Ball pein hammer	
	69608	Martillo uña mod. americano / Mod. americano claw hammer	
	55326	Martillo de nylon / Nylon hammer	
	69520	Maceta goma / Rubber hammer	
5	66875, 66877, 66879, 66881, 66882	Destornilladores mecánico Rotork / Rotork slotted screwdriver	
	66908, 66909	Destornilladores Pozidriv® Rotork / Pozidriv® Rotork screwdrivers	
2	76652, 76653	Destornilladores varilla protegida Rotork / Rotork Insulated screwdrivers	
	76656, 76657	Destornilladores varilla protegida Philips Rotork / Rotork Philips insulated screwdrivers	
	66921, 66923	Destornilladores Torx® Rotork / Rotork Torx® screwdrivers	
1	66071	Destornillador buscapolos / Voltage tester screwdriver	
	63000	Carraca / Ratchet	
2	63003, 63004	Cabezas / Heads	
	69506	Desatascador de muelle / Spring pipe cleaner	
1	68058	Kit reparador de grifos / Valve reseater	
	67019	Paleta mod. Madrid / Madrid bricklayer	
	67021	Espátula / Scraper	



ASISTENCIA DE EQUIPOS DOMÉSTICOS / HOUSE EQUIPMENT KIT / KIT ÉQUIPEMENT DOMESTIQUE / HAUSHALT / ASSISTENZA APPARECCHI DOMESTICI / ASSISTÊNCIA A ELECTRODOMESTICOS / ОБОРУДОВАНИЕ ДЛЯ ДОМА

87 PCS.

COD.	PCS.		
69394	87	51010	9,5
PCS.	Composición / Composition / Composition	Descripción / Description / Description	
29	61958	Juego / Set	1/4", 29 pcs
8	69249	Juego de llaves fijas / Open end wrenches set	8 pcs
9	61870, 61871, 61872, 61873, 61874, 61875, 61876, 61877, 61878	Llaves de pipa / Angled sockets	6/7/8/9/10/11/12/13/14
8	61499	Juego llaves Allen / Allen keys wrenches Set	1,5/2/2,5/3/4/5/5,5/6 hex.
1	61111	Llave ajustable Unique Titacrom® / Unique Titacrom® adjustable wrench	8"
	76651, 76652, 76653	Destornilladores varilla protegida Rotork / Rotork Insulated screwdrivers	
	76655, 76656, 76657	Destornilladores varilla protegida Philips Rotork / Rotork Philips insulated screwdrivers	
3	76659, 76660, 76661	Destornilladores varilla protegida Pozidriv® Rotork / Rotork Pozidriv® insulated screwdrivers	
	66917, 66918, 66919	Destornilladores Torx® Rotork / Rotork Torx® screwdrivers	
	66928, 66929, 66930	Destornilladores punta esfera Rotork / Rotork ball tip screwdrivers	
	66070	Destornillador buscapolos / Voltage tester screwdriver	
	62331	Alicate universal Titacrom® Bimat / Titacrom® Bimat combination pliers	-
	62337	Alicate b/plana Titacrom® Bimat / Titacrom® Bimat flat nose pliers	
	62338	Alicate b/redonda Titacrom® Bimat / Titacrom® Bimat round nose pliers	
	62341	Alicate telefonista b/curva Titacrom® Bimat / Titacrom® Bimat bent nose pliers	
	62343	Alicate c/diagonal Titacrom® Bimat / Titacrom® Bimat cutting pliers	
	62349	Alicate pelacables Bimat / Bimat wirestripper pliers	
1	62445	Tenaza Pico Loro Bimat / Bimat groove joint	
	62177	Tenaza Grip curva / Curved Grip pliers	
	69531	Pinza / Tweezers	45°
	69530	Pinza b/fina / Neat tips tweezer	
	62242	Alicate mini b/plana Titacrom® Bimat / Titacrom® Bimat flat nose electronic pliers	
	62247	Alicate mini c/diagonal Titacrom® Bimat / Titacrom® Bimat diagonal cutting wlectronic pliers	
	62246	Alicate mini b/aguja Titacrom® Bimat / itacrom Bimat long needle nose electronic pliers	
	63097	Cortatubos mini / Tube Cutter	22 mm
	69501	Cutter	
	69601	Martillo ebanista / Joiners hammer	



JUEGOS PROFESIONALES DE MECÁNICA / PROFESSIONAL SETS FOR MECHANICS / SETS DE MÉCANICIENS PROFESSIONNELS / PROFESSIONAL WERKZEUGSETS FÜR MECHANIKER / SET PROFESSIONALI DI MECCANICA / JOGOS PROFISSIONAL DE MECÂNICA / НАБОР МЕХАНИКА
BASIC 39 PCS.

COD.	PCS.		Medidas en / Sizes in / Mesures en	
51550	39		Sur de Europa / Southern Europe / Le Sud d'Europe	50994 mm 6

Composición / Composition / Composition

65172, 69622, 61496, 66440, 66439, 66405, 66402, 66401, 62135, 61908, 61438, 66732, 61435, 61443, 61321, 61320, 61319, 61318, 61317, 61316, 61315, 61314, 61313, 63975, 61312, 63974, 61311, 62606, 62343, 62332

COD.	PCS.		Medidas en / Sizes in / Mesures en	
51553	39		América / America / L'Amérique	50994 inch 6

Composición / Composition / Composition

60423, 65363, 69622, 61495, 66440, 66439, 55335, 55333, 55331, 62106, 61908, 62603, 60422, 60421, 60420, 66732, 61444, 61443, 61442, 61438, 61435, 60430, 60429, 60428, 60427, 60426, 60425, 60424, 62343, 62332

ADVANCED 72 PCS.

COD.	PCS.		Medidas en / Sizes in / Mesures en	
51551	72		Sur de Europa / Southern Europe / Le Sud d'Europe	50995 mm 18

Composición / Composition / Composition

55326, 63681, 63645, 63609, 63573, 63537, 65158, 65172, 69622, 61496, 66053, 66052, 61741, 61738, 61736, 61733, 61732, 61731, 61730, 61729, 61728, 61727, 66442, 66441, 66440, 66439, 66408, 66407, 66405, 66402, 66401, 62135, 63915, 63399, 63398, 63397, 63396, 63395, 63394, 61908, 61437, 61458, 61455, 61816, 61815, 61814, 61813, 61811, 61810, 61809, 61808, 61807, 61806, 61805, 61804, 61803, 61802, 61801, 61800, 62606, 62343, 62339, 62332

COD.	PCS.		Medidas en / Sizes in / Mesures en	
51554	72		América / America / L'Amérique	50995 inch 18

Composición / Composition / Composition

55326, 63681, 63645, 63609, 63573, 63537, 65158, 65363, 69622, 61495, 66053, 66052, 60354, 60352, 60351, 60349, 60348, 60347, 60345, 60344, 60343, 60342, 66442, 66441, 66440, 66439, 55338, 55337, 55335, 55333, 55331, 62106, 63915, 63399, 63398, 63397, 63396, 63395, 63394, 61908, 61437, 61458, 61455, 60474, 60473, 60472, 60471, 60470, 60469, 60468, 60467, 60459, 60466, 60465, 60464, 60463, 60462, 60461, 60460, 62606, 62343, 62339, 62332

■ MASTER 103 PCS.



COD.	PCS.			Medidas en / Sizes in / Mesures en		
51552	103	Sur de Europa / Southern Europe / Le Sud d'Europe	50995, 50994	50986	mm	25

Composición / Composition / Composition

55326, 63396, 63299, 76732, 76654, 76652, 63573, 62848, 62847, 63436, 63416, 62871, 63681, 63645, 63609, 63537, 65158, 65172, 62824, 69622, 63876, 62170, 56567, 61496, 61741, 61738, 61736, 61733, 61732, 61731, 61730, 61729, 61728, 61727, 76735, 76658, 76657, 76656, 76655, 76733, 76653, 62707, 63915, 51257, 65480, 65603, 61908, 61438, 66732, 61435, 61443, 61321, 61320, 61319, 61318, 61317, 61316, 61315, 61314, 61313, 63975, 61312, 63974, 61311, 62603, 61437, 61458, 61455, 61816, 61815, 61814, 61813, 61811, 61810, 61809, 61808, 61807, 61806, 61805, 61804, 61803, 61802, 61801, 61800, 62606, 62097, 76595, 76591, 76683

COD.	PCS.			Medidas en / Sizes in / Mesures en		
51555	103	América / America / L'Amérique	50995, 50994	50986	inch	25

Composición / Composition / Composition

55326, 63299, 62848, 62847, 63436, 63416, 62871, 63396, 63681, 63645, 63609, 63573, 63537, 65158, 65362, 62824, 69622, 63876, 62170, 56567, 61495, 60354, 60352, 60351, 60349, 60348, 60347, 60345, 60344, 60343, 60342, 76735, 76658, 76657, 76656, 76655, 75178, 75177, 75176, 75175, 75174, 62707, 63916, 51257, 65480, 65603, 61908, 61444, 61442, 61438, 66732, 61435, 61443, 60430, 60429, 60428, 60247, 60426, 60425, 60424, 60423, 60422, 60421, 60420, 62606, 61437, 61458, 61455, 60474, 60473, 60472, 60471, 60470, 60469, 60468, 60467, 60459, 60466, 60465, 60464, 60463, 60462, 60461, 60460, 62606, 62097, 76595, 76591, 76583

■ JUEGOS PROFESIONALES DE FONTANERÍA / PROFESSIONAL PLUMBING SETS / SETS PROFESSIONNELS POUR PLOMBERIE / PROFESSIONAL WERKZEUGSETS FÜR KLEMPNER / SET PROFESSIONALI DI IDRAULICA / JOGOS PROFISSIONAL DE CANALIZAÇÃO / НАБОР САПТЕХНІКА

■ BASIC 8 PCS.



COD.	PCS.			
51535	8	Sur de Europa / Southern Europe / Le Sud d'Europe	50994	8

Composición / Composition / Composition

61004, 63171, 61480, 62135, 63205, 68003, 61237, 63119

COD.	PCS.			
51538	8	Centro y norte de Europa / Central and northern Europe / Centre et Nord d'Europe	50994	8

Composición / Composition / Composition

61011, 63171, 61480, 62135, 63205, 68003, 61237, 63119

COD.	PCS.			
51541	8	América / America / L'Amérique	50994	8

Composición / Composition / Composition

63119, 63171, 61480, 62106, 61017, 63205, 68001, 61237

■ **ADVANCED 38 PCS.**



COD.	PCS.			
51536	38	Sur de Europa / Southern Europe / Le Sud d'Europe	50994, 50984	15

Composición / Composition / Composition

55326, 63097, 61004, 63370, 61708, 61707, 65148, 65172, 63205, 68003, 63171, 61237, 69614, 63119, 66053, 66052, 66440, 66439, 66404, 66402, 66401, 62135, 61480, 61511, 61706, 61705, 61704, 61703, 61702, 61701, 62333

COD.	PCS.			
51539	38	Centro y norte de Europa / Central and northern Europe / Centre et Nord d'Europe	50994, 50984	15

Composición / Composition / Composition

55326, 63097, 61011, 63370, 61708, 61707, 65148, 65172, 63205, 68003, 63171, 61237, 69614, 63119, 66053, 66052, 66440, 66439, 66404, 66402, 66401, 62135, 61480, 61511, 61706, 61705, 61704, 61703, 61702, 61701, 62333

COD.	PCS.			
51542	40	América / America / L'Amérique	50994, 50984	15



Composición / Composition / Composition

55326, 63097, 65148, 63370, 61480, 61017, 65362, 63205, 68001, 63171, 61237, 69614, 63119, 66053, 66052, 66440, 66439, 55334, 55332, 55331, 62106, 61495, 60311, 60309, 60310, 60306, 60305, 60304, 60303, 60302, 62333

BE SAFE...BE EFFICIENT



■ MASTER 56 PCS.



COD.	PCS.				
51537	56	Sur de Europa / Southern Europe / Le Sud d'Europe	50995, 50984	50986	21

Composición / Composition / Composition

63076, 58641, 55326, 63097, 68178, 68182, 63299, 61708, 61707, 62848, 62847, 63436, 63416, 62871, 63396, 68180, 68175, 63208, 63121, 61004, 65148, 68059, 65172, 63205, 68003, 63171, 61237, 69614, 63876, 63119, 66053, 66052, 66440, 66439, 66404, 66402, 66401, 62707, 61481, 61035, 61511, 61706, 61705, 61704, 61703, 61702, 61701, 62343, 62333

COD.	PCS.				
51540	56	Centro y norte de Europa / Central and northern Europe / Centre et Nord d'Europe	50995, 50984	50986	21

Composición / Composition / Composition

63076, 58641, 55326, 63097, 68178, 68182, 65172, 61011, 63299, 65158, 68059, 68180, 68175, 63208, 63121, 62848, 62847, 63436, 63416, 62871, 63396, 63205, 68003, 63171, 61237, 69614, 63876, 63119, 66053, 66052, 61708, 61707, 66440, 66439, 66404, 66402, 66401, 62707, 61481, 61035, 61511, 61706, 61705, 61704, 61703, 61702, 61701, 62343, 62333

COD.	PCS.				
51543	56	América / America / L'Amérique	50995, 50984	50986	21



Composición / Composition / Composition

63076, 58641, 55326, 63097, 68178, 68182, 63299, 61708, 61707, 62848, 62847, 63436, 63416, 62871, 63396, 68180, 68175, 63208, 63121, 61004, 65148, 68059, 65172, 63205, 68003, 63171, 61237, 69614, 63876, 63119, 66053, 66052, 66440, 66439, 66404, 66402, 66401, 62707, 61481, 61035, 61511, 61706, 61705, 61704, 61703, 61702, 61701, 62343, 62333

■ JUEGOS PROFESIONALES DE ELECTRICIDAD / PROFESSIONAL ELECTRICIAN SETS / SETS PROFESSIONNELS POUR ÉLECTRICIENS / PROFESSIONAL WERKZEUGSETS FÜR ELEKTRIKER / SET PROFESSIONALI DI ELETTRICITÀ / JOGOS PROFISIONAL DE ELETRICIDADE / НАБОР ЭЛЕКТРИКА

■ BASIC 12 PCS.



COD.	PCS.		Medidas en / Sizes in / Mesures en		
51544	12	Sur de Europa / Southern Europe / Le Sud d'Europe	50983	mm	5

Composición / Composition / Composition

76603, 76552, 76654, 76652, 73042, 73035, 76595, 76583, 76657, 76656, 76653, 76651

COD.	PCS.			Medidas en / Sizes in / Mesures en	
51547	12	América / America / L'Amérique	50983	inch	5

Composición / Composition / Composition

76603, 76552, 73042, 73035, 76595, 76583, 76657, 76656, 75177, 75176, 75175, 75174

■ ADVANCED 34 PCS.



COD.	PCS.			Medidas en / Sizes in / Mesures en	
51545	34	Sur de Europa / Southern Europe / Le Sud d'Europe	50994	mm	11

Composición / Composition / Composition

76603, 55326, 73036, 73004, 76552, 76732, 76654, 76652, 73073, 73071, 73067, 73065, 73064, 73062, 73042, 76147, 73035, 79058, 65158, 65173, 69603, 63876, 65868, 73257, 76595, 76583, 76735, 76658, 76657, 76656, 76655, 76733, 76653, 76651

COD.	PCS.			Medidas en / Sizes in / Mesures en	
51548	34	América / America / L'Amérique	50994	inch	11

Composición / Composition / Composition

76603, 55326, 73036, 73001, 76552, 73054, 73052, 73050, 73048, 73047, 73046, 73042, 76147, 73035, 79058, 65158, 65363, 69603, 63876, 65868, 73257, 76595, 76583, 76735, 76858, 76757, 76656, 76555, 75179, 75178, 75177, 75176, 75175, 75174



■ MASTER 54 PCS.



COD.	PCS.				Medidas en / Sizes in / Mesures en	
51546	54	Sur de Europa / Southern Europe / Le Sud d'Europe	50983, 50984	50986	mm	15

Composición / Composition / Composition

73040, 51257, 58641, 79058, 73036, 73035, 73029, 63876, 69603, 55326, 79373, 79372, 79371, 79370, 76552, 73073, 73071, 73069, 73068, 73067, 73066, 73065, 73064, 73063, 73062, 65868, 76735, 76733, 76732, 76730, 76658, 76657, 76656, 76655, 76654, 76653, 76652, 76651, 75203, 75202, 75158, 75157, 75156, 73004, 76603, 76597, 76595, 76590, 76583, 73257, 73042, 62602, 65173, 65158

COD.	PCS.				Medidas en / Sizes in / Mesures en	
51549	54	América / America / L'Amérique	50983, 50984	50986	inch	15



Composición / Composition / Composition

69603, 76603, 76590, 58641, 55326, 73036, 73001, 76552, 65868, 79382, 79381, 79380, 79377, 73054, 73052, 73051, 73050, 73049, 73048, 73047, 73046, 73045, 73043, 73029, 73042, 73035, 73040, 79058, 65158, 65363, 51257, 63876, 75203, 75202, 79491, 79490, 79489, 62602, 73257, 76597, 76595, 76583, 76735, 76658, 76657, 76656, 76655, 75179, 75178, 75177, 75176, 75175, 75174, 75172

■ BANDEJAS / TRAYS / PLATEAUX / ABLAGEKASTEN / PANNELLO / TABULEIROS / ПОДДОНЫ





■ 15 PCS.

COD.	PCS.		L x W (mm)	
68954	15	51025, 51039, 50950, 51045	565 x 405	2,0
PCS.	Composición / Composition / Composition		Descripción / Description / Description	
12	66400, 66401, 66403, 66405, 66439, 66440, 66478, 66479, 66480, 66481, 66483, 66484		Destornilladores Mastertork: mecánico, Philips, Torx® / Screwdrivers Mastertork: slotted, Philips, Torx®	
3	62332, 62339, 62343		Alicates Titacrom®: universal, telefonista y corte diagonal / Pliers Titacrom®: combination, long nose, diagonal plier	





■ 26 PCS.

COD.	PCS.		L x W (mm)	
68955	26	51025, 51039, 50950, 51045	565 x 405	5,5
PCS.	Composición / Composition / Composition		Descripción / Description / Description	
26	61725, 61726, 61727, 61728, 61729, 61730, 61731, 61732, 61733, 61734, 61735, 61736, 61737, 61738, 61739, 61740, 61741, 61742, 61743, 61744, 61745, 61746, 61747, 61748, 61749, 61750		Llaves combinadas cromado aeroespacial / Aerospaceal chrome plating combination wrenches	





89 PCS.

COD.	PCS.		L x W (mm)	
68956	89	51025, 51039, 50950, 51045	565x 405	7,5
PCS.	Composición / Composition / Composition		Descripción / Description / Description	
46	61800, 61801, 61802, 61803, 61804, 61805, 61806, 61807, 61808, 61809, 61810, 61811, 61812, 61813, 61814, 61815, 61816, 61817, 61818, 61819, 61822, 61823, 61311, 61312, 61313, 61314, 61315, 61316, 61317, 61318, 61319, 61320, 61321, 65044, 65045, 65046, 65047, 65048, 65049, 65050, 65051, 65052, 65053, 65054, 65055, 65056		Llaves de vaso / Socket wrenches	
2	61438, 61440		Mango correrizo en T / Sliding "T" handle	
4	61442, 61444, 61455, 61458		Alargadera / Extension	
2	62603, 62606		Llave de carraca reversible / Reversible ratchet handle	
	61435, 61437		Articulación universal / Universal joint	
1	66731		Destornillador portapuntas magnético / Screwdriver magnetic bitholder	
15	58230, 58231, 58232, 58242, 58243, 58247, 58248, 58253, 58254, 58255, 58164, 58165, 58271, 58155, 58272		Puntas de destornillador Masterbit / Masterbit bits	
3	61501, 61502, 61503		Llaves hexagonales / Hexagonal keys	
1	66264		Adaptador portapuntas magnético / Magnetic bit holder	
13	66733, 66734, 66735, 66737, 66738, 66740, 66741, 66748, 66750, 66751, 66752, 66753, 66755		Puntas atornilladoras con vaso / Socket bits	





16 PCS.

COD.	PCS.		L x W (mm)	
68957	16	51025, 51039, 50950, 51045	565 x 405	4,5
PCS.	Composición / Composition / Composition		Descripción / Description / Description	
1	63742		Arco de sierra / Hack Saw	
3	62169, 62170, 62171		Tijera articulada / Aviation tin snip	
1	63876		Cortador / Cutter	
3	62848, 62850, 62852		Cortafíos / Chisel	
6	63394, 63395, 63396, 63397, 63398, 63399		Botador / Pin punch	
1	69621		Martillo alemán / German type machinist's hammer	
	55326		Maceta de nylon / Nylon hammer	



18 PCS.

COD.	PCS.		L x W (mm)	
68958	18	51025, 51039, 50950, 51045	565 x 405	3,5
PCS.	Composición / Composition / Composition		Descripción / Description / Description	
11	63498, 63570, 63606, 63642, 63678, 63714, 63715, 63716, 63717, 63718, 63719		Limas / Files	
4	62180, 62181, 62182, 62183		Alicates Circlips / Circlips pliers	
	62172		Tenaza Grip / Grip plier	
1	61944		Llave ajustable / Adjustable wrench	
	62707		Tenaza de canal / Box joint	



7 PCS.

COD.	PCS.		L x W (mm)	
68959	7	51025, 51039, 50950, 51045	565 x 405	2,0
PCS.	COD.	Descripción / Description / Description		
	69534	Tijera electricista / Electrician's scissors		
	62494	Tenaza para engastar / Crimping plier		
	62151	Tenaza cortacables / Cable cutters		
1	65167	Flexómetro / Measuring tape		
	65293	Nivel trapezoidal profesional / Professional bridge type spirit level		
	65480	Calibre / Caliper		
	66073	Buscapolos / Voltage tester		



MOBILIARIO INDUSTRIAL MODULAR / MODULAR INDUSTRIAL FURNITURE / MOBILIER INDUSTRIEL MODULAIRE / MODULARE INDUSTRIEMÖBEL / MOBILIO INDUSTRIALE MODULARE / MOBILIÁRIO INDUSTRIAL MODULAR / МОДУЛЬНАЯ ПРОИЗВОДСТВЕННАЯ МЕБЕЛЬ
ARMARIO ALTO / TALL CABINET / ARMOIRE HAUTE / GROSSE WERKZEUGSCHRANK / ARMADIO ALTO / ARMÁRIO VERTICAL 2 PORTAS / ВЫСОКИЙ ШКАФ-КАБИНЕТ

■ 915 × 458 × 2000

COD.	L x W x H (mm)	Kg
50111	915 x 458 x 2000	78



■ 600 × 458 × 2000

COD.	L x W x H (mm)	Kg
50112	600 x 458 x 2000	55,5

ARMARIO DE PARED / WALL CABINET / ARMOIRE MURALE / WANDSCHRANK / ARMADIO DA PARETE / ARMÁRIO DE PAREDE / НАСТЕННЫЙ ШКАФ-КАБИНЕТ

■ 680 × 281 × 350

COD.	L x W x H (mm)	Kg
50113	680 x 281 x 350	10

CARACTERÍSTICAS / FEATURES / CARACTÉRISTIQUES

Puerta abatible hacia arriba / Lift up door / Porte rabattable vers le haut

COD.	L x W x H (mm)	Kg
50114	680 x 281 x 350	8,4

CARACTERÍSTICAS / FEATURES / CARACTÉRISTIQUES

Puerta corredera / Sliding door / Porte coulissante

PANEL COLGADOR / HANGING PANEL / PANNEAU ACROCHABLE / RÜCKWANDTAFEL / PANNELI FORATI / PAINEL PARA FERRAMENTAS / НАСТЕННАЯ ПАНЕЛЬ

COD.	L x W x H (mm)	Kg
50137	1052 x 614,5 x 24	5,3
50136	1052 x 800 x 24	6,9

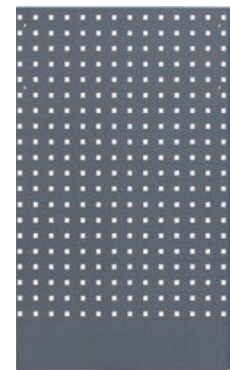
BALDA / SHELF / ÉTAGÈRE / REGAL / MENSOLA / PRATELEIRA / ПОЛКА

COD.	L x W x H (mm)	Kg
50138	602 x 281 x 178	3

ESPECIFICACIONES TÉCNICAS / TECHNICAL SPECIFICATION / DÉTAILS TECHNIQUES

Máx. capacidad de carga / Max. weight capacity / Capacité maximum de charge 5 kg

COLUMNNA / PILLAR / COLONNE / SAÛLE / COLONNA / COLUNA / РЕЙКА
1420 × 65 × 30

COD.	L x W x H (mm)	Kg
50116	65 x 30 x 1420	2

1420 × 32,5 × 30

COD.	L x W x H (mm)	Kg
50117	32,5 x 30 x 1420	1,5

ARMARIO DOBLE PUERTA / 2 DOOR CABINET / ARMOIRE À DOUBLE PORTE / 2 TÜRIGE SCHRANK / ARMADIO A DUE PORTE / ARMÁRIO BAIXO COM PORTA SIMPLES / ДВУДВЕРНЫЙ КАБИНЕТ
680 × 458 × 910

COD.	L x W x H (mm)	Kg
50118	680 x 458 x 910	38

CARACTERÍSTICAS / FEATURES / CARACTÉRISTIQUES

1 balda incluida / 1 shelf included / 1 étagère incluse

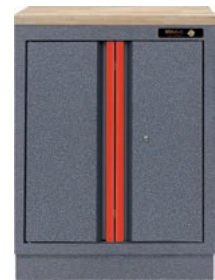
PAPELERA CON SUJETAPAPEL / TRASH BIN WITH PAPER HOLDER / CORBEILLE A PRESSE-PAPIER / MÜLLEIMER MIT PAPIERHALTER / MODULO FISSO DI SERVIZIO PER ARREDO OFFICINA / CAIXOTE DO LIXO COM SUPORTE DE PAPEL / МУСОРОСБОРНИК С ВСТРОЕННЫМ ДЕРЖАТЕЛЕМ РУЛОННОЙ БУМАГИ
680 × 458 × 910

COD.	L x W x H (mm)	Kg
50119	680 x 458 x 910	54,7

ARMARIO DE 4 CAJONES / 4 DRAWER CABINET / SERVANTES + 4 TIROIRS / WERKZEUGWAGEN MIT 4 SCHUBLADEN / ARMADIO CON 4 CASSETTI / CARROS + 4 GAVETAS / ШКАФ-КАБИНЕТ С ЧЕТЫРЬЯ ВЪДВИЖНЫМИ ЯЩИКАМИ
680 × 458 × 910

COD.	L x W x H (mm)	Kg
50120	680 x 458 x 910	55,3



ARMARIO DE 5 CAJONES / 5 DRAWER CABINET / SERVANTES + 5 TIROIRS / WERKZEUGWAGEN MIT 5 SCHUBLADEN / ARMADIO CON 5 CASSETTI / CARROS + 5 GAVETAS / ШКАФ-КАБИНЕТ С ПЯТЬЮ ВЫДВИЖНЫМИ ЯЩИКАМИ

680 × 458 × 910

COD.	L x W x H (mm)	Kg
50121	680 x 458 x 910	59



680 × 458 × 731,5

COD.	L x W x H (mm)	Kg
50122	680 x 458 x 731,5	46

CARACTERÍSTICAS / FEATURES / CARACTÉRISTIQUES

Con ruedas / With wheels / Avec roues

TABLERO LAMINADO / PRESSED WOODEN BOARD / PLATEAU BOIS / HOLZ-ARBEITSPLATTE / PANNELLO LAMINATO / TAMPO EM MADEIRA / СТОЛЕШНИЦА ИЗ ПРЕССОВАННОЙ ДРЕВЕСИНЫ

COD.	L x W x H (mm)	Kg
50123	680,5 x 463 x 36	6
50124	1361 x 463 x 36	12,5
50125	2041,5 x 463 x 36	19

TABLERO INOXIDABLE / STAINLESS BOARD / PLATEAU INOX / EDELSTAHL BRETT / PANNELLO INOX / TAMPO EM AÇO INOXIDÁVEL / СТОЛЕШНИЦА ИЗ Н/Ж СТАЛИ

COD.	L x W x H (mm)	Kg
50126	680,5 x 463 x 38	10,5
50127	1361 x 463 x 38	21
50128	2041,5 x 463 x 38	32

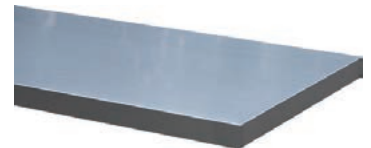
ARMARIO DE PARED EN ESQUINA / CORNER WALL CABINET / ARMOIRE MURALE D'ANGLE / ECKWAND KABINETT / ARMADIO DA PARETE AD ANGOLO / ARMÁRIO DE ESQUINA / УГЛОВОЙ НАСТЕННЫЙ КАБИНЕТ

865 × 865 × 350

COD.	L x W x H (mm)	Kg
50130	865 x 865 x 350	21

MADERA LAMINADA EN ESQUINA / CORNER PRESSED WOOD / PLATEAU D'ANGLE BOIS / ECKIG GEPRESSTEM HOLZBRETT / COPERCHIO IN LEGNO LAMINATO AD ANGOLO / TABULEIRO ANGULAR EM MADEIRA / УГЛОВАЯ СТОЛЕШНИЦА ИЗ ПРЕССОВАННОЙ ДРЕВЕСИНЫ

865 × 865 × 36

COD.	L x W x H (mm)	Kg
50131	865 x 865 x 36	13



TAPA INOXIDABLE EN ESQUINA / CORNER STAINLESS TOP / COUVERCLE INOX, D'ANGLE / ECKIGE EDELSTAHL BRETT / COPERCHIO IN INOX AD ANGOLO / TABULEIRO ANGULAR EM AÇO INOXIDÁVEL / УГЛОВАЯ СТОЛЕШНИЦА ИЗ Н/Ж СТАЛИ

865 × 865 × 38,6

COD.	L x W x H (mm)	Kg
50133	865 x 865 x 38,6	18

ARMARIO BAJO EN ESQUINA / CORNER BASE CABINET / MEUBLE D'ANGLE BAS / ECKUNTERSCHRANK / ARMADIO BASSO AD ANGOLO / ARMÁRIO BAIXO DE ESQUINA / УГЛОВОЙ СТОЛ-КАБИНЕТ

865 × 865 × 910

COD.	L x W x H (mm)	Kg
50134	865 x 865 x 910	41,5

COMBINATION 1

2275 × 2000

COD.	L x H (mm)
50101	2275 x 2000

PCS.	COD.
1	50111
	50113
	50114
2	50137
	50116
	50117
1	50124
	50121
	50118

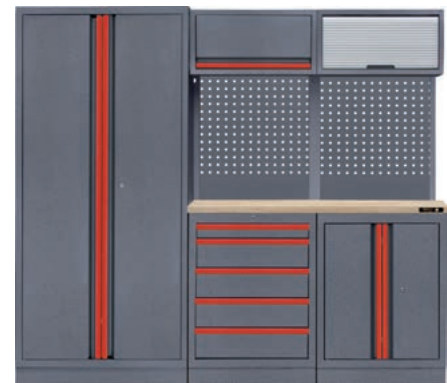
COMBINATION 2

2640 × 2000

COD.	L x H (mm)
50102	2640 x 2000

PCS.	COD.
1	50112
2	50113
1	50114
3	50137
	50116
	50117
	50125
1	50121
	50122
	50118



COMBINATION 3

2955 x 2000

COD.	L x H (mm)	
50103	2955 x 2000	
PCS.	COD.	
1	50111	
2	50113	
1	50114	
3	50137	
	50116	
	50117	
	50125	
1	50121	
	50119	
	50118	

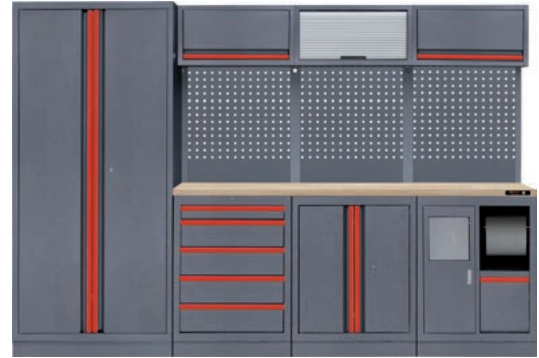

COMBINATION 4

4235 x 2000

COD.	L x H (mm)	
50104	4235 x 2000	
PCS.	COD.	
1	50111	
	50112	
2	50113	
	50114	
4	50137	
5	50116	
2	50127	
	50121	
	50119	
1	50118	
	50120	

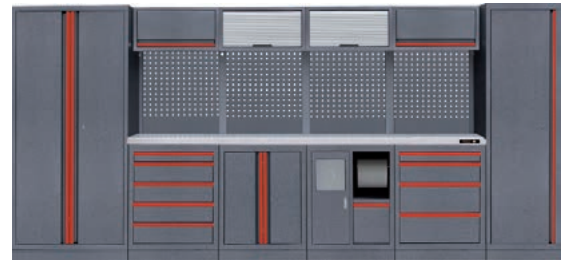

COMBINATION 5

4915 x 2000

COD.	L x H (mm)	
50105	4915 x 2000	
PCS.	COD.	
	50111	
	50112	
	50121	
1	50118	
	50120	
	50122	
	50119	
2	50114	
3	50113	
5	50137	
6	50116	
	50128	
1	50127	



COMBINACIÓN DE ALMACENAJE EN ESQUINA / CORNER STORAGE COMBINATION / COMBINAISON DE STOCKAGE D'ANGLE / ECKIGE LAGERUNGSKOMBINATION / COMBINAZIONE STOCCAGGIO AD ANGOLO / COMBINAÇÃO DE ARMAZÉM DE ESQUINA / УГЛОВОЙ КОМПЛЕКТ МЕБЕЛИ

865 x 2000

COD.	L x H (mm)
50106	865 x 2000
PCS.	COD.
1	50130
2	50116
	50117
1	50131
2	50136
1	50134

MESAS DE TRABAJO / WORK BENCHES / TABLES DE MONTEUR / ARBEITSTISCHE / TAVOLI DI LAVORO / BANCADAS DE TRABALHO / РАБОЧИЕ ВЕРСТАКИ

1200 x 600 x 865

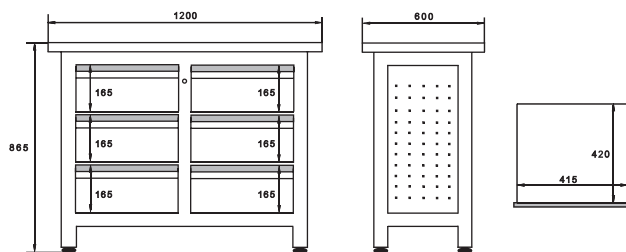

COD.	L x W x H (mm)	Kg
51557	1200 x 600 x 865	79

ESPECIFICACIONES TÉCNICAS / TECHNICAL SPECIFICATION / DÉTAILS TECHNIQUES

Cajones con rodamientos / Ball-bearing slides / Tiroirs à roulement	6
Sistema de cierre centralizado / Central locking system / Système de fermeture centralisée	●
Capacidad de carga estática total / Total static weight capacity / Capacité totale de charge statique	300 Kg

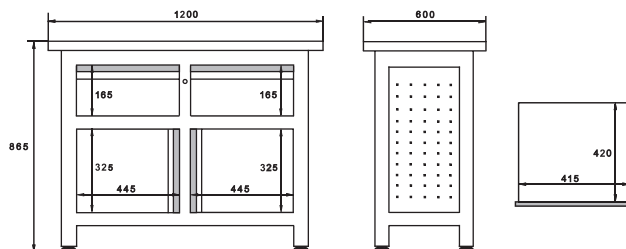

COD.	L x W x H (mm)	Kg
51556	1200 x 600 x 865	68

ESPECIFICACIONES TÉCNICAS / TECHNICAL SPECIFICATION / DÉTAILS TECHNIQUES

Puertas / Doors / Portes	2
Cajones con rodamientos / Ball-bearing slides / Tiroirs à roulement	2
Sistema de cierre centralizado / Central locking system / Système de fermeture centralisée	●
Capacidad de carga estática total / Total static weight capacity / Capacité totale de charge statique	300 Kg



■ 1690 × 600 × 865

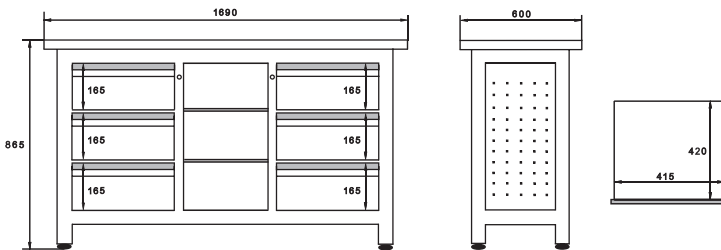

NI

COD.	L x W x H (mm)	
51578	1690 x 600 x 865	99

ESPECIFICACIONES TÉCNICAS / TECHNICAL SPECIFICATION / DÉTAILS TECHNIQUES

Baldas / Shelves / Étagères	3
Cajones con rodamientos / Ball-bearing slides / Tiroirs à roulement	6
Sistema de cierre centralizado / Central locking system / Système de fermeture centralisée	●
Capacidad de carga estática total / Total static weight capacity / Capacité totale de charge statique	300 Kg

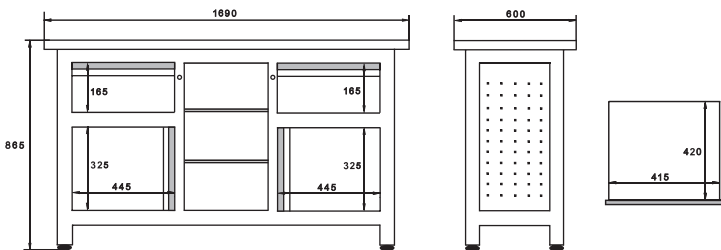

NI

COD.	L x W x H (mm)	
51577	1690 x 600 x 865	87

ESPECIFICACIONES TÉCNICAS / TECHNICAL SPECIFICATION / DÉTAILS TECHNIQUES

Baldas / Shelves / Étagères	3
Puertas / Doors / Portes	2
Cajones con rodamientos / Ball-bearing slides / Tiroirs à roulement	2
Sistema de cierre centralizado / Central locking system / Système de fermeture centralisée	●
Capacidad de carga estática total / Total static weight capacity / Capacité totale de charge statique	300 Kg



EGA Master

ART IN INNOVATION

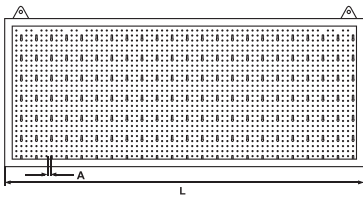
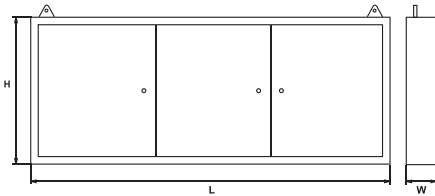
ARMARIOS DE PARED / WALL CABINETS / ARMOIRES MURALES / WANDWERKZEUGSCHRANK / ARMADI DA PARETE / ARMÁRIO DE PAREDE / ШКАФ ИНСТРУМЕНТАЛЬНЫЙ НАСТЕННЫЙ
1200 x 200 x 600

COD.	L x W x H (mm)	A (mm)	 Kg
51475	1200 x 200 x 600	10	17,5

ESPECIFICACIONES TÉCNICAS / TECHNICAL SPECIFICATION / DÉTAILS TECHNIQUES

Baldas / Shelves / Étagères	3
Puertas / Doors / Portes	3
Ganchos incluidos / Hook included / Crochets inclus	6 cortos: cod. 90172 - 12 largos: cod. 90173 / 6 shorts: cod. 90172 - 12 longs: cod. 90173 / 6 courts: cod. 90172 - 12 longs: cod. 90173
Cerradura con llave / Key lock / Serrure avec clé	●

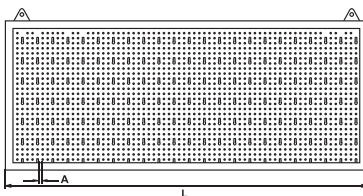
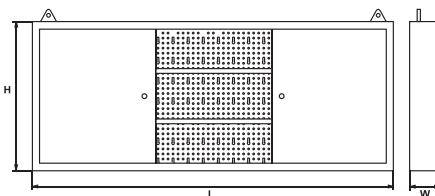
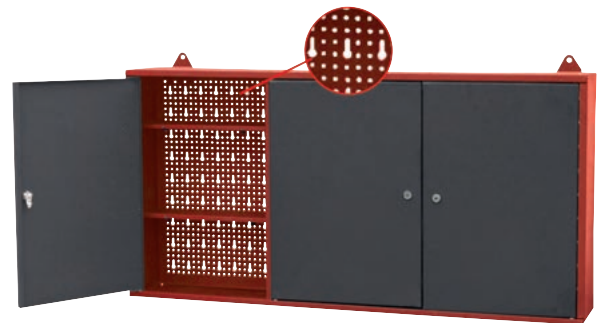

COD.	L x W x H (mm)	A (mm)	 Kg
51476	1200 x 200 x 600	10	15,6

ESPECIFICACIONES TÉCNICAS / TECHNICAL SPECIFICATION / DÉTAILS TECHNIQUES

Baldas / Shelves / Étagères	3
Puertas / Doors / Portes	2
Ganchos incluidos / Hook included / Crochets inclus	6 cortos: cod. 90172 - 12 largos: cod. 90173 / 6 shorts: cod. 90172 - 12 longs: cod. 90173 / 6 courts: cod. 90172 - 12 longs: cod. 90173
Cerradura con llave / Key lock / Serrure avec clé	●

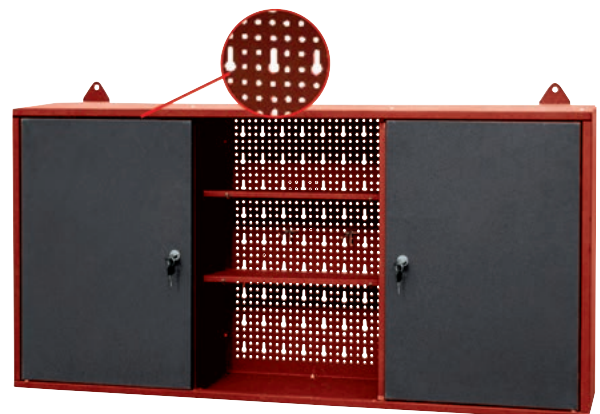

REPUESTOS / SPARE PARTS / RECHANGES / ERSATZTEILE / ACCESSORI / ACESSORIOS / ЗАПАСНЫЕ ЧАСТИ

COD.	PCS.	Descripción / Description / Description	Cortos / Shorts / Courts
90172	6	Ganchos / Hooks / Crochets	Cortos / Shorts / Courts
90173	12		Largos / Longs / Longs

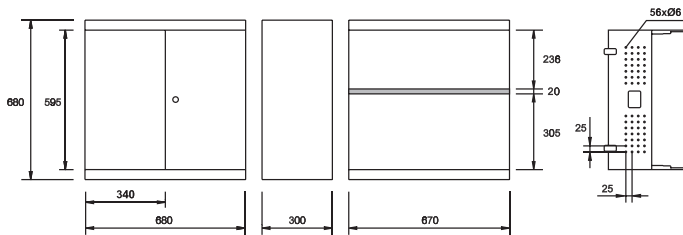
680 x 300 x 680

COD.	L x W x H (mm)	Kg
50976	680 x 300 x 680	17

ESPECIFICACIONES TÉCNICAS / TECHNICAL SPECIFICATION / DÉTAILS TECHNIQUES

Baldas / Shelves / Étagères	1
Cerradura con llave / Key lock / Serrure avec clé	●

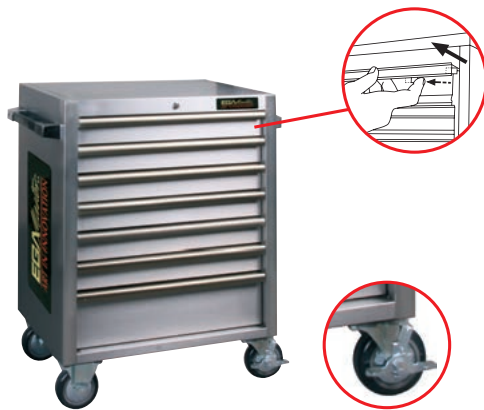
ARMARIOS-CARROS DE HERRAMIENTAS 100% INOX / ROLLER CABINETS 100% INOX / SERVANTES À ROUES 100% INOX / WERKZEUGWAGEN 100% INOX / CASSETTIERE MOBILI 100% INOX / CARRO DE FERRAMENTAS 100% INOX / ШКАФЫ-ТЕЛЕЖКИ ДЛЯ ИНСТРУМЕНТОВ 100% НЕРЖАВЕЮЩАЯ СТАЛЬ
680 x 470 x 935

Sistema antivuelco con botón de seguridad de apertura individual por bandeja
 Anti-overtum system with individual safety open button in each tray
 Système anti-renversement avec bouton de sécurité d'ouverture individuelle par tiroir

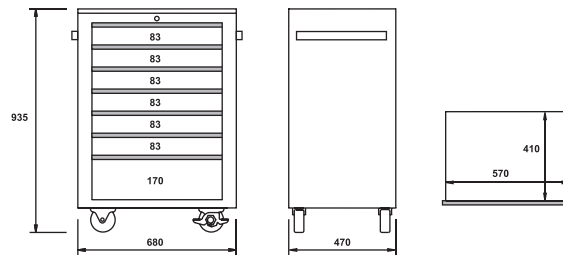

INOX

COD.	L x W x H (mm)	Material estructura / Material structure / Structure matériaux	Kg
51558	680 x 470 x 935	Inox 304	63

ESPECIFICACIONES TÉCNICAS / TECHNICAL SPECIFICATION / DÉTAILS TECHNIQUES

Material / Material / Matière	Exterior e interior 100% INOX / Exterior and interior 100% INOX / Extérieur et intérieur 100% INOX
Cajones con rodamientos / Ball-bearing slides / Tiroirs à roulement	7
2 ruedas fijas y 2 giratorias con freno / 2 fixed and 2 revolving with brake wheels / 2 roues fixes et 2 roues giratoires avec frein	5" x 1,5"
Capacidad cajones de altura 83 mm / Capacity in 83 mm height drawers / Capacité des tiroirs de 83 mm de haut	25 Kg
Capacidad cajones de altura 170 mm / Capacity in 170 mm height drawers / Capacité des tiroirs de 170 mm de haut	30 Kg
Capacidad de carga estática total / Total static weight capacity / Capacité totale de charge statique	320 Kg
Sistema de cierre centralizado / Central locking system / Système de fermeture centralisée	●
Asa lateral reforzada / Reinforced side handle / Poignées latérale renforcée	●
Sistema antivuelco en cada bandeja / Anti-overtum system in each drawers / Système anti-renversement dans chaque tiroir	●

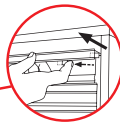
1056 x 470 x 1110



Sistema antivuelco con botón de seguridad de apertura individual por bandeja
Anti-overturn system with individual safety open button in each tray
Système anti-renversement avec bouton de sécurité d'ouverture individuelle par tiroir

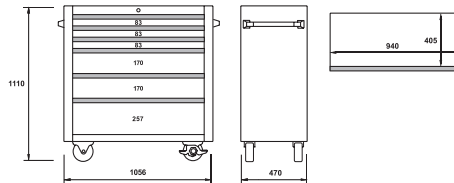

INOX

COD.	L x W x H (mm)	Material estructura / Material structure / Structure matériaux	Kg
51559	1056 x 470 x 1110	Inox 304	95

ESPECIFICACIONES TÉCNICAS / TECHNICAL SPECIFICATION / DÉTAILS TECHNIQUES

Material / Material / Matière	Exterior e interior 100% INOX / Exterior and interior 100% INOX / Extérieur et intérieur 100% INOX
Cajones con rodamientos / Ball-bearing slides / Tiroirs à roulement	6
2 ruedas fijas y 2 giratorias con freno / 2 fixed and 2 revolving with brake wheels / 2 roues fixes et 2 roues giratoires avec frein	5" x 1,5"
Capacidad cajones de altura 83 mm / Capacity in 83 mm height drawers / Capacité des tiroirs de 83 mm de haut	25 Kg
Capacidad cajones de altura 170 mm / Capacity in 170 mm height drawers / Capacité des tiroirs de 170 mm de haut	30 Kg
Capacidad cajones de altura 257 mm / Capacity in 257 mm height drawers / Capacité des tiroirs de 257 mm de haut	30 kg
Capacidad de carga estática total / Total static weight capacity / Capacité totale de charge statique	500 kg
Sistema de cierre centralizado / Central locking system / Système de fermeture centralisée	●
Asa lateral reforzada / Reinforced side handle / Poignées latérale renforcée	●
Sistema antivuelco en cada bandeja / Anti-overturn system in each drawers / Système anti-renversement dans chaque tiroir	●

ARMARIOS-CARROS DE HERRAMIENTAS DE SUPERFICIES INOX* / INOX SURFACE ROLLER CABINETS* / SERVANTES À ROUES AVEC SURFACE INOX* / WERKZEUGWAGEN MIT INOX OBERFLÄCHE* / CASSETTIERE MOBILI PORTAUTENSILI DI SUPERFICI INOX* / ARMÁRIOS-CARROS DE FERRAMENTA DE SUPERFÍCIE INOX* / ШКАФЫ-ТЕЛЕЖКИ ДЛЯ ИНСТРУМЕНТОВ С ПОКРЫТИЕМ ИЗ НЕРЖАВЕЮЩЕЙ СТАЛИ*

680 x 470 x 935

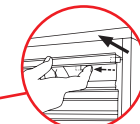

Sistema antivuelco con botón de seguridad de apertura individual por bandeja
Anti-overturn system with individual safety open button in each tray
Système anti-renversement avec bouton de sécurité d'ouverture individuelle par tiroir

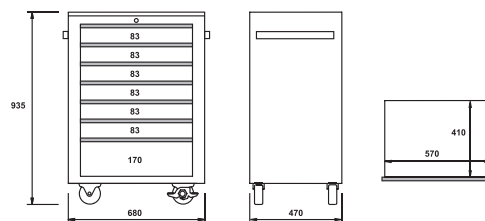

INOX

COD.	L x W x H (mm)	Material estructura / Material structure / Structure matériaux	Material ruedas / Wheel material / Matière roues	Kg
51478	680 x 470 x 935	Inox 430	Inox 304	63

ESPECIFICACIONES TÉCNICAS / TECHNICAL SPECIFICATION / DÉTAILS TECHNIQUES

Material* / Material* / Matière*	Exterior 100% INOX - Interior: Acero pintado - Placa fijación ruedas: Acero / Exterior 100% INOX - Interior: Painted Steel - Wheel fixing plate: Steel / Extérieur 100% INOX - Intérieur: Acier peint - Roues de fixation: Acier
Cajones con rodamientos / Ball-bearing slides / Tiroirs à roulement	7
2 ruedas fijas y 2 giratorias con freno / 2 fixed and 2 revolving with brake wheels / 2 roues fixes et 2 roues giratoires avec frein	5" x 1,5"
Capacidad cajones de altura 83 mm / Capacity in 83 mm height drawers / Capacité des tiroirs de 83 mm de haut	25 Kg
Capacidad cajones de altura 170 mm / Capacity in 170 mm height drawers / Capacité des tiroirs de 170 mm de haut	30 Kg
Capacidad de carga estática total / Total static weight capacity / Capacité totale de charge statique	320 Kg
Sistema de cierre centralizado / Central locking system / Système de fermeture centralisée	●
Asa lateral reforzada / Reinforced side handle / Poignées latérale renforcée	●
Sistema antivuelco en cada bandeja / Anti-overturn system in each drawers / Système anti-renversement dans chaque tiroir	●

680 × 470 × 1420

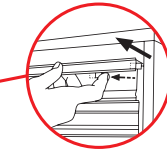

Sistema antivuelco con botón de seguridad de apertura individual por bandeja
 Anti-overtum system with individual safety open button in each tray
 Système anti-renversement avec bouton de sécurité d'ouverture individuelle par tiroir

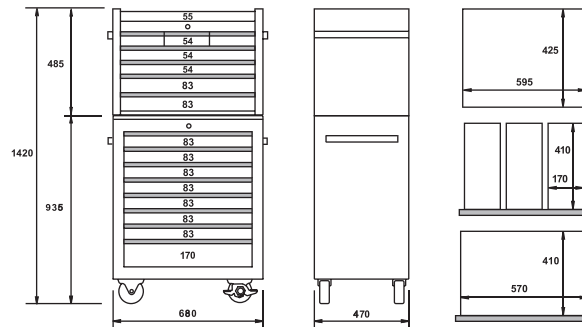

INOX

COD.	L x W x H (mm)	Kg	Material estructura / Material structure / Structure matériaux	Material ruedas / Wheel material / Matière roues
51563	680 x 470 x 1420	109	Inox 430	Inox 304

ESPECIFICACIONES TÉCNICAS / TECHNICAL SPECIFICATION / DÉTAILS TECHNIQUES

Material* / Material* / Matière*	Exterior 100% INOX - Interior: Acero pintado - Placa fijación ruedas: Acero / Exterior 100% INOX - Interior: Painted Steel - Wheel fixing plate: Steel / Extérieur 100% INOX - Intérieur: Acier peint - Roues de fixation: Acier
Cajones con rodamientos / Ball-bearing slides / Tiroirs à roulement	14
Tapa con doble pistón neumático / Double pneumatic absorber equipped lid / Couvercle avec double piston pneumatique	●
2 ruedas fijas y 2 giratorias con freno / 2 fixed and 2 revolving with brake wheels / 2 roues fixes et 2 roues giratoires avec frein	5" x 1,5"
Capacidad cajones 170,5 x 410 x 54 mm / Capacity in 170,5 x 410 x 54mm drawers / Capacité des tiroirs de 170,5 x 410 x 54 mm	15 kg
Capacidad cajones 570 x 410 x 54 mm / Capacity in 570 x 410 x 54 mm drawers / Capacité des tiroirs de 570 x 410 x 54 mm	25 kg
Capacidad cajones de altura 83 mm / Capacity in 83 mm height drawers / Capacité des tiroirs de 83 mm de haut	25 Kg
Capacidad cajones de altura 170 mm / Capacity in 170 mm height drawers / Capacité des tiroirs de 170 mm de haut	30 Kg
Capacidad de carga estática total / Total static weight capacity / Capacité totale de charge statique	470 kg
Sistema de cierre centralizado / Central locking system / Système de fermeture centralisée	●
Asa lateral reforzada / Reinforced side handle / Poignées latérale renforcée	●
Sistema antivuelco en cada bandeja / Anti-overtum system in each drawers / Système anti-renversement dans chaque tiroir	●

■ 1056 x 470 x 1110

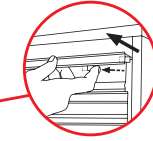

Sistema antivuelco con botón de seguridad de apertura individual por bandeja
 Anti-overturn system with individual safety open button in each tray
 Système anti-renversement avec bouton de sécurité d'ouverture individuelle par tiroir

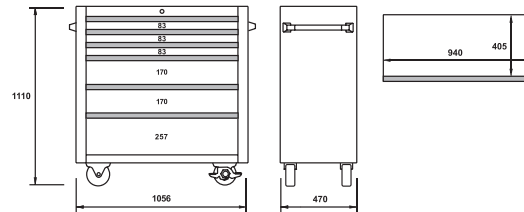

INOX

COD.	L x W x H (mm)	Material estructura / Material structure / Structure matériaux	Material ruedas / Wheel material / Matière roues	
51561	1056 x 470 x 1110	Inox 430	Inox 304	95

ESPECIFICACIONES TÉCNICAS / TECHNICAL SPECIFICATION / DÉTAILS TECHNIQUES

Material* / Material* / Matière*	Exterior 100% INOX - Interior: Acero pintado - Placa fijación ruedas: Acero / Exterior 100% INOX - Interior: Painted Steel - Wheel fixing plate: Steel / Extérieur 100% INOX - Intérieur: Acier peint - Roues de fixation: Acier
Cajones con rodamientos / Ball-bearing slides / Tiroirs à roulement	6
2 ruedas fijas y 2 giratorias con freno / 2 fixed and 2 revolving with brake wheels / 2 roues fixes et 2 roues giratoires avec frein	5" x 1,5"
Capacidad cajones de altura 83 mm / Capacity in 83 mm height drawers / Capacité des tiroirs de 83 mm de haut	25 Kg
Capacidad cajones de altura 170 mm / Capacity in 170 mm height drawers / Capacité des tiroirs de 170 mm de haut	30 Kg
Capacidad cajones de altura 257 mm / Capacity in 257 mm height drawers / Capacité des tiroirs de 257 mm de haut	30 kg
Capacidad de carga estática total / Total static weight capacity / Capacité totale de charge statique	500 kg
Sistema de cierre centralizado / Central locking system / Système de fermeture centralisée	●
Asa lateral reforzada / Reinforced side handle / Poignées latérale renforcée	●
Sistema antivuelco en cada bandeja / Anti-overturn system in each drawers / Système anti-renversement dans chaque tiroir	●

EGGA Master

ART IN INNOVATION

■ 1056 × 470 × 1686

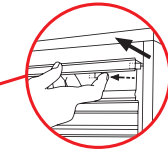

Sistema antivuelco con botón de seguridad de apertura individual por bandeja
Anti-oveturn system with individual safety open button in each tray
Système anti-renversement avec bouton de sécurité d'ouverture individuelle par tiroir

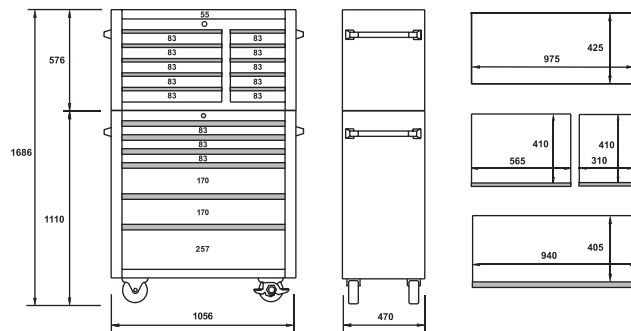

INOX

COD.	L x W x H (mm)	Kg	Material estructura / Material structure / Structure matériaux	Material ruedas / Wheel material / Matière roues
51564	1056 x 470 x 1686	168	Inox 430	Inox 304





ESPECIFICACIONES TÉCNICAS / TECHNICAL SPECIFICATION / DÉTAILS TECHNIQUES

Material* / Material* / Matière*

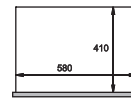
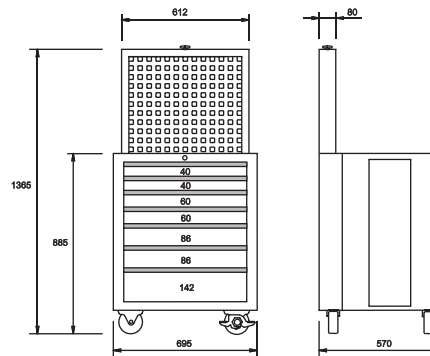
Exterior 100% INOX - Interior: Acero pintado - Placa fijación ruedas: Acero
/ Exterior 100% INOX - Interior: Painted Steel - Wheel fixing plate: Steel /
Extérieur 100% INOX - Intérieur: Acier peint - Roues de fixation: Acier

Cajones con rodamientos / Ball-bearing slides / Tiroirs à roulement	16
2 ruedas fijas y 2 giratorias con freno / 2 fixed and 2 revolving with brake wheels / 2 roues fixes et 2 roues giratoires avec frein	5" x 1,5"
Capacidad cajones de altura 83 mm / Capacity in 83 mm height drawers / Capacité des tiroirs de 83 mm de haut	25 Kg
Capacidad cajones de altura 170 mm / Capacity in 170 mm height drawers / Capacité des tiroirs de 170 mm de haut	30 Kg
Capacidad cajones de altura 257 mm / Capacity in 257 mm height drawers / Capacité des tiroirs de 257 mm de haut	30 kg
Capacidad de carga estática total / Total static weight capacity / Capacité totale de charge statique	700 kg
Sistema de cierre centralizado / Central locking system / Système de fermeture centralisée	●
Asa lateral reforzada / Reinforced side handle / Poignées latérale renforcée	●
Sistema antivuelco en cada bandeja / Anti-oveturn system in each drawers / Système anti-renversement dans chaque tiroir	●

ARMARIOS-CARROS DE HERRAMIENTAS / ROLLER CABINETS / SERVANTES À ROUES / WERKSTATTWAGEN / CASSETTIERE MOBILI / CARRO DE FERRAMENTAS COM GAVETAS / ТЕЛЕЖКИ НА РОЛИКАХ
695 × 570 × 1365

COD.	L x W x H (mm)		Color / Colour / Couleur
51045	695 x 570 x 1365	60	
51305			
51306			
51307			

ESPECIFICACIONES TÉCNICAS / TECHNICAL SPECIFICATION / DÉTAILS TECHNIQUES

7 cajones con rodamientos / 7 ball-bearing slides / 7 tiroirs à roulement	●
Número de agujeros del panel / Number of holes of the panel / Nombre de trous du panneau	12 x 12
Estructura reforzada / Reinforced heavy duty structure / Structure renforcée	●
Sistema de cierre centralizado en el panel y en el carro / Central locking system in the panel and in the cabinet / Système de fermeture centralisée dans le panneau et la servante	●
Capacidad de carga estática total / Total static weight capacity / Capacité totale de charge statique	500 kg
Capacidad cajones de altura 142 mm / Capacity in 142 mm height drawers / Capacité des tiroirs de 142 mm de haut	50 kg
Capacidad cajones de altura 86 mm / Capacity in 86 mm height drawers / Capacité des tiroirs de 86 mm de haut	40 kg
Capacidad cajones de altura 60 mm / Capacity in 60 mm height drawers / Capacité des tiroirs de 60 mm de haut	30 kg
Capacidad cajones de altura 40 mm / Capacity in 40 mm height drawers / Capacité des tiroirs de 40 mm de haut	30 kg
2 ruedas fijas y 2 giratorias con freno / 2 fixed and 2 revolving with brake wheels / 2 roues fixes et 2 roues giratoires avec frein	5" x 2"
Panel accionado neumáticamente / Pneumatically operated panel / Panneau actionné pneumatiquement	●

GANCHOS OPCIONALES / OPTIONAL HOOKS / CROCHETS OPTIONNELS / OPTIONALE HAKEN / GANCI OPZIONALI / GANCHOS OPCIONAIS / ДОПОЛНИТЕЛЬНЫЕ КРЮЧКИ

	COD.	L x W x H (mm)
	90312	56 x 65 x 87



	COD.	L x W x H (mm)
	90315	72 x 76 x 37



	COD.	L x W x H (mm)
	90313	56 x 65 x 35

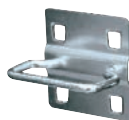



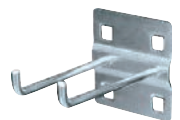

	COD.	L x W x H (mm)
	90316	56 x 65 x 35



	COD.	L x W x H (mm)
	90314	370 x 65 x 34





CAJAS DE PLÁSTICO / PLASTIC BINS / CAISSES EN PLASTIQUE / KUNSTOFF BEHÄLTER / CASSETTE DI PLASTICA / CAIXA DE PLÁSTICO / ПЛАСТИКОВЫЕ ЯЩИКИ

COD.	L x W x H (mm)			Color / Colour / Couleur
90185	140 x 105 x 75		80	
90186	220 x 140 x 125	90184	180	
90187	270 x 140 x 125		260	







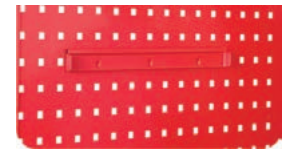

SOPORTE PARA CAJAS DE PLÁSTICO / BIN HOLDER FOR PLASTIC BINS / SUPPORT POUR CAISSE EN PLASTIQUE / HALTER FÜR KUNSTOFF BEHÄLTER / SUPPORTO PER CASSETTE DI PLASTICA / SUPORTE PARA CAIXAS PLÁSTICAS / ПОДСТАВКА ДЛЯ ПЛАСТИКОВЫХ ЯЩИКОВ

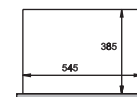
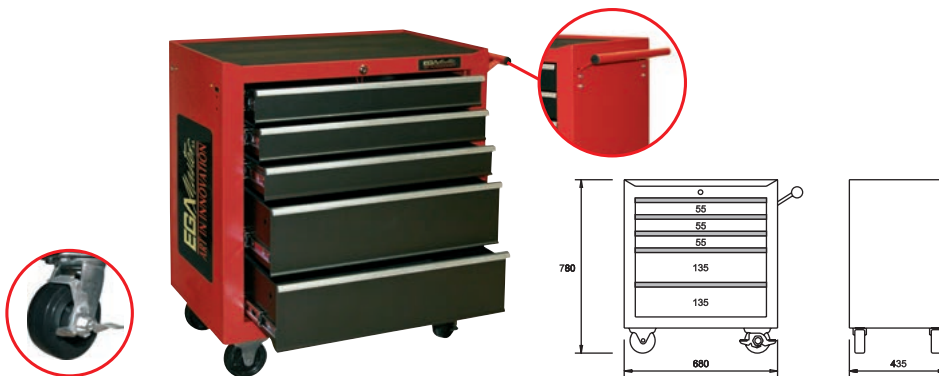
COD.	Descripción / Description / Description		L x W x H (mm)	
90184	Ganchos / Hooks / Crochets	260	440 x 39 x 19,5	90185 90186 90187



690 x 435 x 780



COD.	L x W x H (mm)		Color / Colour / Couleur
51024	690 x 435 x 780	40	
51483			
51495			
51507			

ESPECIFICACIONES TÉCNICAS / TECHNICAL SPECIFICATION / DÉTAILS TECHNIQUES



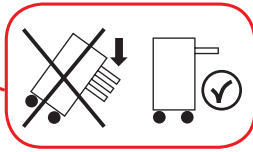

5 cajones con rodamientos / 5 ball-bearing slides / 5 tiroirs à roulement	●
2 ruedas fijas y 2 giratorias con freno / 2 fixed and 2 revolving with brake wheels / 2 roues fixes et 2 roues giratoires avec frein	4" x 1"
Capacidad cajones de altura 55 mm / Capacity in 55 mm height drawers / Capacité des tiroirs de 55 mm de haut	30 kg
Capacidad cajones de altura 135 mm / Capacity in 135 mm height drawers / Capacité des tiroirs de 135 mm de haut	40 kg
Capacidad de carga estática total / Total static weight capacity / Capacité totale de charge statique	300 kg
Sistema de cierre centralizado / Central locking system / Système de fermeture centralisée	●
Estructura reforzada / Reinforced heavy duty structure / Structure renforcée	●

■ 695 × 470 × 885

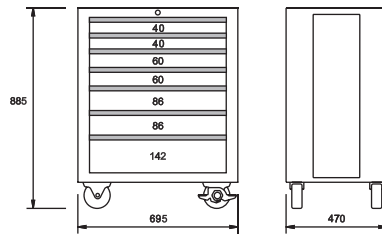

Sistema OODO Antivuelco
OODO Antioverturn System
(Only One Drawer Open)
Système OODO Anti-renversement



COD.	L x W x H (mm)	Kg	Color / Colour / Couleur
51025	695 x 470 x 885	50	
51484			
51496			
51508			

ESPECIFICACIONES TÉCNICAS / TECHNICAL SPECIFICATION / DÉTAILS TECHNIQUES

7 cajones con rodamientos / 7 ball-bearing slides / 7 tiroirs à roulement	●
2 ruedas fijas y 2 giratorias con freno / 2 fixed and 2 revolving with brake wheels / 2 roues fixes et 2 roues giratoires avec frein	5" x 2"
Capacidad cajones de altura 40 mm / Capacity in 40 mm height drawers / Capacité des tiroirs de 40 mm de haut	30 kg
Capacidad cajones de altura 60 mm / Capacity in 60 mm height drawers / Capacité des tiroirs de 60 mm de haut	30 kg
Capacidad cajones de altura 86 mm / Capacity in 86 mm height drawers / Capacité des tiroirs de 86 mm de haut	40 kg
Capacidad cajones de altura 142 mm / Capacity in 142 mm height drawers / Capacité des tiroirs de 142 mm de haut	50 kg
Capacidad de carga estática total / Total static weight capacity / Capacité totale de charge statique	500 kg
Sistema de cierre centralizado / Central locking system / Système de fermeture centralisée	●
Estructura reforzada / Reinforced heavy duty structure / Structure renforcée	●

BE SAFE...BE EFFICIENT



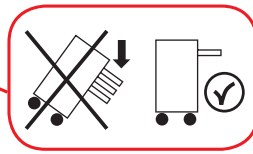

■ 730 × 475 × 1030

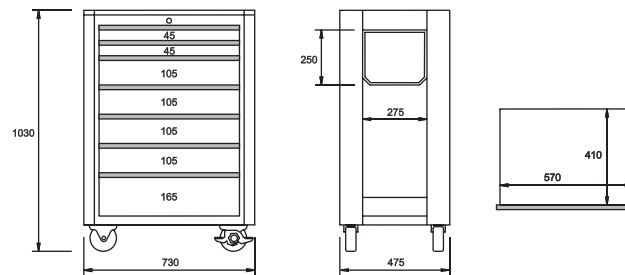

Sistema OODO Antivuelco
OODO Anti-overturn System
(Only One Drawer Open)
Système OODO Anti-renversement



Disponible en 4 colores
Available in 4 colors
Disponible en 4 couleurs

COD.	L x W x H (mm)	Kg	Color / Colour / Couleur
51039	730 x 475 x 1030	50	
51486			
51498			
51510			

ESPECIFICACIONES TÉCNICAS / TECHNICAL SPECIFICATION / DÉTAILS TECHNIQUES

7 cajones con rodamientos / 7 ball-bearing slides / 7 tiroirs à roulement	●
Bandeja lateral plegable / Lateral foldable tray / Plateau latéral pliable	●
Estructura reforzada / Reinforced heavy duty structure / Structure renforcée	●
Sistema antivuelco en cada bandeja / Anti-overturn system in each drawers / Système anti-renversement dans chaque tiroir	●
Sistema de cierre centralizado / Central locking system / Système de fermeture centralisée	●
Capacidad de carga estática total / Total static weight capacity / Capacité totale de charge statique	500 kg
Capacidad cajones de altura 165 mm / Capacity in 165 mm height drawers / Capacité des tiroirs de 165 mm de haut	50 kg
Capacidad cajones de altura 105 mm / Capacity in 105 mm height drawers / Capacité des tiroirs de 105 mm de haut	40 kg
Capacidad cajones de altura 45 mm / Capacity in 45 mm height drawers / Capacité des tiroirs de 45 mm de haut	30 kg
2 ruedas fijas y 2 giratorias con freno / 2 fixed and 2 revolving with brake wheels / 2 roues fixes et 2 roues giratoires avec frein	5" x 2"
Colgador lateral para herramientas / Lateral tool holder / Rangement latéral d'outils	●

730 × 475 × 1500

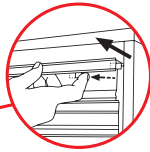

Sistema antivuelco con botón de seguridad de apertura individual por bandeja
Anti-overturn system with individual safety open button in each tray
Système anti-renversement avec bouton de sécurité d'ouverture individuelle par tiroir

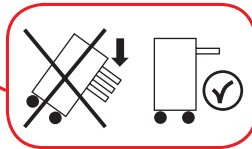

Sistema OODO Antivuelco
OODO Antiovertum System
(Only One Drawer Open)
Système OODO Anti-renversement



Disponible en 4 colores
Available in 4 colors
Disponible en 4 couleurs

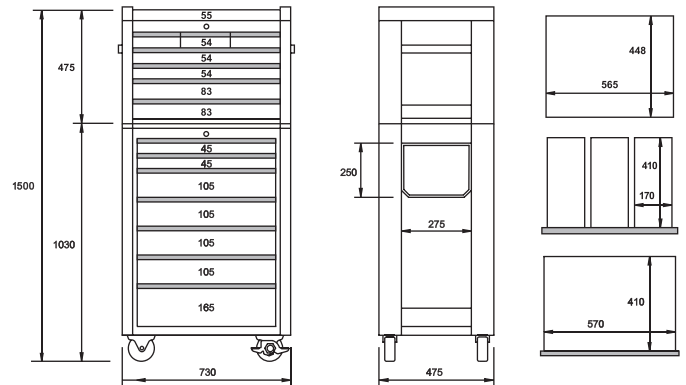

COD.	L x W x H (mm)				Color / Colour / Couleur
51117	730 x 475 x 1500	51039	51075	97	
51516		51486	51490		
51519		51498	51502		
51522		51510	51514		

ESPECIFICACIONES TÉCNICAS / TECHNICAL SPECIFICATION / DÉTAILS TECHNIQUES

14 cajones con rodamientos / 14 ball-bearing slides / 14 tiroirs à roulement	●
Bandeja lateral plegable / Lateral foldable tray / Plateau latéral pliable	●
Estructura reforzada / Reinforced heavy duty structure / Structure renforcée	●
Sistema antivuelco en cada bandeja / Anti-overturn system in each drawers / Système anti-renversement dans chaque tiroir	●
Sistema de cierre centralizado / Central locking system / Système de fermeture centralisée	●
Cofre con asas laterales / Chest with side handles / Coffre avec poignées latérales	●
Cofre: Capacidad de carga estática total / Chest: Total static weight capacity / Coffre: Capacité totale de charge statique	60 kg
Cofre: Capacidad cajones de 570 x 410 x 54 mm / Chest: Capacity in 570 x 410 x 54 mm drawers / Coffre: Capacité des tiroirs de 570 x 410 x 54 mm	8 kg
Cofre: Capacidad cajones de 170 x 410 x 54 mm / Chest: Capacity in 170 x 410 x 54 mm drawers / Coffre: Capacité des tiroirs de 170 x 410 x 54 mm	5 kg
Cofre: Capacidad cajón de altura 85 mm / Chest: Capacity in 85 mm height drawer / Coffre: Capacité du tiroir de 85 mm de haut	10 kg
Cofre: Capacidad cajón de altura 55 mm / Chest: Capacity in 55 mm height drawer / Coffre: Capacité du tiroir de 55 mm de haut	9 kg
Capacidad de carga estática total / Total static weight capacity / Capacité totale de charge statique	560 kg
Capacidad cajones de altura 165 mm / Capacity in 165 mm height drawers / Capacité des tiroirs de 165 mm de haut	50 kg
Capacidad cajones de altura 105 mm / Capacity in 105 mm height drawers / Capacité des tiroirs de 105 mm de haut	40 kg
Capacidad cajones de altura 45 mm / Capacity in 45 mm height drawers / Capacité des tiroirs de 45 mm de haut	30 kg
2 ruedas fijas y 2 giratorias con freno / 2 fixed and 2 revolving with brake wheels / 2 roues fixes et 2 roues giratoires avec frein	5" x 2"
Colgador lateral para herramientas / Lateral tool holder / Rangement latéral d'outils	●

■ 722 × 482 × 1013

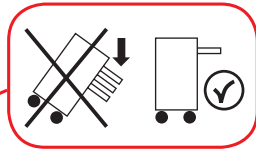



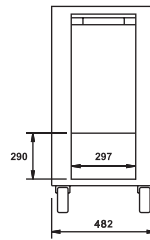
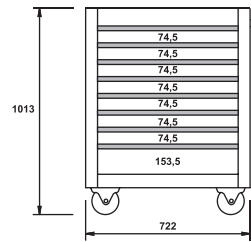

Sistema OODO Antivuelco
OODO Antiovertum System
(Only One Drawer Open)
Système OODO Anti-renversement

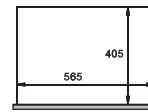

Disponible en 4 colores
Available in 4 colors
Disponible en 4 couleurs



COD.	L x W x H (mm)		Color / Colour / Couleur
50977	722 x 482 x 1013	73	
50978			
50979			
50980			

ESPECIFICACIONES TÉCNICAS / TECHNICAL SPECIFICATION / DÉTAILS TECHNIQUES

8 cajones con rodamientos / 8 ball-bearing slides / 8 tiroirs à roulement	●
2 ruedas fijas y 2 giratorias con freno / 2 fixed and 2 revolving with brake wheels / 2 roues fixes et 2 roues giratoires avec frein	5" x 2"
Capacidad cajones de altura 74,5 mm / Capacity in 74,5 mm height drawers / Capacité des tiroirs de 74,5 mm de haut	25 kg
Capacidad cajones de altura 153,5 mm / Capacity in 153,5 mm height drawers / Capacité des tiroirs de 153,5 mm de haut	30 kg
Capacidad de carga estática total / Total static weight capacity / Capacité totale de charge statique	500 kg
Sistema de cierre centralizado / Central locking system / Système de fermeture centralisée	●
Sistema antivuelco en cada bandeja / Anti-overflow system in each drawers / Système anti-renversement dans chaque tiroir	●
Estructura reforzada / Reinforced heavy duty structure / Structure renforcée	●
Papelera / Trash tray / Poubelle	●

EGA Master



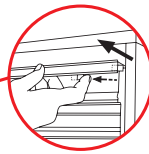

ART IN INNOVATION

■ 1110 × 480 × 1015

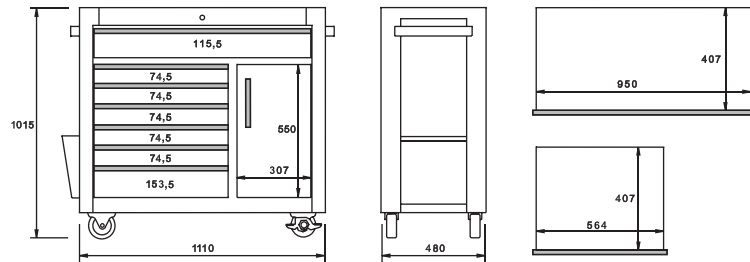

Sistema antivuelco con botón de seguridad de apertura individual por bandeja
Anti-overtum system with individual safety open button in each tray
 Système anti-renversement avec bouton de sécurité d'ouverture individuelle par tiroir



COD.	L x W x H (mm)	Kg	Color / Colour / Couleur
50950	1110 x 480 x 1015	98	
50951			
50952			
50953			

ESPECIFICACIONES TÉCNICAS / TECHNICAL SPECIFICATION / DÉTAILS TECHNIQUES

2 ruedas fijas y 2 giratorias con freno / <i>2 fixed and 2 revolving with brake wheels</i> / 2 roues fixes et 2 roues giratoires avec frein	5" x 2"
Estructura reforzada / <i>Reinforced heavy duty structure</i> / Structure renforcée	●
Sistema antivuelco en cada bandeja / <i>Anti-overtum system in each drawers</i> / Système anti-renversement dans chaque tiroir	●
Sistema de cierre centralizado / <i>Central locking system</i> / Système de fermeture centralisée	●
Capacidad de carga estática total / <i>Total static weight capacity</i> / Capacité totale de charge statique	800 kg
Capacidad cajones de altura 153,5 mm / <i>Capacity in 153,5 mm height drawers</i> / Capacité des tiroirs de 153,5 mm de haut	30 kg
Capacidad cajones de altura 74,5 mm / <i>Capacity in 74,5 mm height drawers</i> / Capacité des tiroirs de 74,5 mm de haut	25 kg
Capacidad cajón de altura 115,5 mm y anchura 956,5 mm / <i>Capacity in 115,5 mm height and 956,5 mm width drawer</i> / Capacité tiroir 115,5 mm de haut et 956,5 mm de large	30 kg
7 cajones y 1 armario / <i>7 drawers and 1 closet</i> / 7 tiroirs et une armoire	●
Papelera / <i>Trash tray</i> / Poubelle	●

BE SAFE...BE EFFICIENT

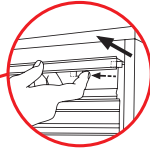





Sistema antivuelco con botón de seguridad de apertura individual por bandeja
Anti-overtum system with individual safety open button in each tray
Système anti-renversement avec bouton de sécurité d'ouverture individuelle par tiroir

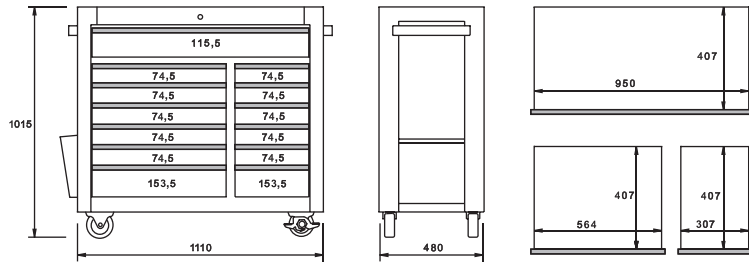

Disponible en 4 colores
Available in 4 colors
Disponible en 4 couleurs



COD.	L x W x H (mm)	Kg	Color / Colour / Couleur
50954	1110 x 480 x 1015	100	
50955			
50956			
50957			

ESPECIFICACIONES TÉCNICAS / TECHNICAL SPECIFICATION / DÉTAILS TECHNIQUES

2 ruedas fijas y 2 giratorias con freno / 2 fixed and 2 revolving with brake wheels / 2 roues fixes et 2 roues giratoires avec frein	5" x 2"
Estructura reforzada / Reinforced heavy duty structure / Structure renforcée	●
Sistema antivuelco en cada bandeja / Anti-overtum system in each drawers / Système anti-renversement dans chaque tiroir	●
Sistema de cierre centralizado / Central locking system / Système de fermeture centralisée	●
Capacidad de carga estática total / Total static weight capacity / Capacité totale de charge statique	800 kg
Capacidad cajones de altura 153,5 mm / Capacity in 153,5 mm height drawers / Capacité des tiroirs de 153,5 mm de haut	30 kg
Capacidad cajones de altura 74,5 mm / Capacity in 74,5 mm height drawers / Capacité des tiroirs de 74,5 mm de haut	25 kg
Capacidad cajón de altura 115,5 mm y anchura 956,5 mm / Capacity in 115,5 mm height and 956,5 mm width drawer / Capacité tiroir 115,5 mm de haut et 956,5 mm de large	30 kg
13 cajones / 13 drawers / 13 tiroirs	●
Papelera / Trash tray / Poubelle	●

EGA Master

ART IN INNOVATION

■ 1434 x 560 x 1075

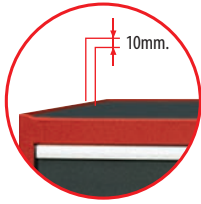

Zona de acople de seguridad para evitar que el cofre superior se caiga
Safety coupling area to prevent the upper chest to fall
 Zone d'assemblage de sécurité pour éviter que le coffre supérieur tombe

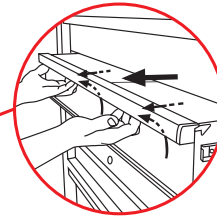

Sistema antivuelco con barra longitudinal de seguridad de apertura individual por bandeja
Anti-tilt system with individual safety open longitudinal bar in each tray
 Système anti-renversement avec barre longitudinale de sécurité d'ouverture individuelle par tiroir

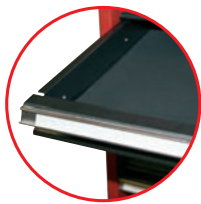

Protección de espuma EVA en cajones
Protecting EVA foam in drawer
 Protection en mousse EVA dans les tiroirs

6"x2"
PARA MÁXIMA ESTABILIDAD
FOR THE BEST STABILITY
POUR UNE STABILITÉ, MAXIMALE

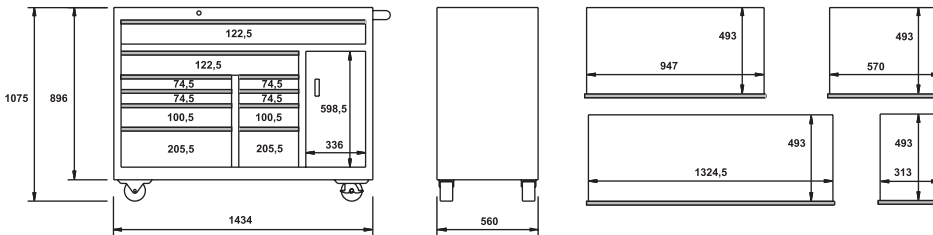

COD.	L x W x H (mm)	Kg	Color / Colour / Couleur
51073	1434 x 560 x 1075	155	
51489			
51501			
51513			

ESPECIFICACIONES TÉCNICAS / TECHNICAL SPECIFICATION / DÉTAILS TECHNIQUES

2 ruedas fijas y 2 giratorias con freno / 2 fixed and 2 revolving with brake wheels / 2 roues fixes et 2 roues giratoires avec frein	6" x 2"
Sistema antivuelco en cada bandeja / Anti-tilt system in each drawers / Système anti-renversement dans chaque tiroir	●
Sistema de cierre centralizado / Central locking system / Système de fermeture centralisée	●
Capacidad de carga estática total / Total static weight capacity / Capacité totale de charge statique	800 kg
Capacidad cajones de altura 205,5 mm / Capacity in 205,5 mm height drawers / Capacité des tiroirs de 205,5 mm de haut	50 kg
Capacidad cajones de altura 122,5 mm / Capacity in 122,5 mm height drawers / Capacité des tiroirs de 122,5 mm de haut	40 kg
Capacidad cajones de altura 100,5 mm / Capacity in 100,5 mm height drawers / Capacité des tiroirs de 100,5 mm de haut	35 kg
Capacidad cajones de altura 74,5 mm / Capacity in 74,5 mm height drawers / Capacité des tiroirs de 74,5 mm de haut	30 kg
10 cajones con rodamientos y armario / 10 drawer with ball bearings and 1 closet / 10 tiroirs à roulement et une armoire	●
Estructura reforzada / Reinforced heavy duty structure / Structure renforcée	●

■ 1434 × 560 × 1720

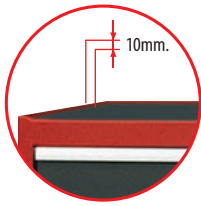

Zona de acople de seguridad para evitar que el cofre superior se caiga
Safety coupling area to prevent the upper chest to fall
 Zone d'assemblage de sécurité pour éviter que le coffre supérieur tombe

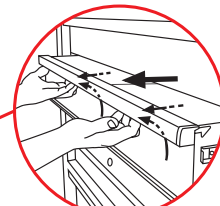

Sistema antivuelco con barra longitudinal de seguridad de apertura individual por bandeja
Anti-overturn system with individual safety open longitudinal bar in each tray
 Système anti-renversement avec barre longitudinale de sécurité d'ouverture individuelle par tiroir

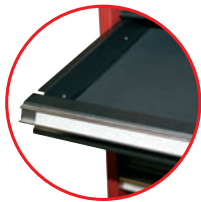

Protección de espuma EVA en cajones
Protecting EVA foam in drawer
 Protection en mousse EVA dans les tiroirs

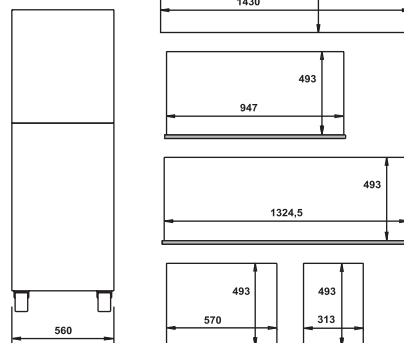
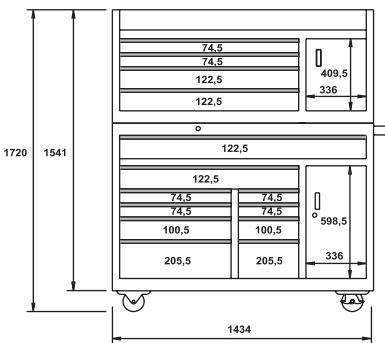



Disponible en 4 colores
Available in 4 colors
 Disponible en 4 couleurs

COD.	L x W x H (mm)			Color / Colour / Couleur	
51074	1434 x 560 x 1720	51073	51072		256
51517		51489	51488		
51520		51501	51500		
51523		51513	51512		

ESPECIFICACIONES TÉCNICAS / TECHNICAL SPECIFICATION / DÉTAILS TECHNIQUES

2 ruedas fijas y 2 giratorias con freno / 2 fixed and 2 revolving with brake wheels / 2 roues fixes et 2 roues giratoires avec frein	6" x 2"
Sistema antivuelco en cada bandeja / Anti-overturn system in each drawers / Système anti-renversement dans chaque tiroir	●
Sistema de cierre centralizado / Central locking system / Système de fermeture centralisée	●
Capacidad de carga estática total / Total static weight capacity / Capacité totale de charge statique	1.100 gr
Capacidad cajones de altura 205,5 mm / Capacity in 205,5 mm height drawers / Capacité des tiroirs de 205,5 mm de haut	50 kg
Capacidad cajones de altura 122,5 mm / Capacity in 122,5 mm height drawers / Capacité des tiroirs de 122,5 mm de haut	40 kg
Capacidad cajones de altura 100,5 mm / Capacity in 100,5 mm height drawers / Capacité des tiroirs de 100,5 mm de haut	35 kg
Capacidad cajones de altura 74,5 mm / Capacity in 74,5 mm height drawers / Capacité des tiroirs de 74,5 mm de haut	30 kg
14 cajones con rodamientos y 2 armarios / 14 drawer with ball bearings and 2 closets / 14 tiroirs à roulement et 2 armoires	●
Estructura reforzada / Reinforced heavy duty structure / Structure renforcée	●



ESTANTERIAS MÓVILES CON MÉNSULAS / TROLLEYS WITH SHELVES / RAYONNAGES MOBILES AVEC ÉTAGÈRES / MOBILE REGALE MIT KONSOLEN / SCAFFALI MOBILI CON MENSOLE / ESTANTE MÓVEL COM PRATELEIRAS / ТЕЛЕЖКА С ПОЛКАМИ
COMPONENTES / COMPONENTS / COMPOSANTS / KOMPONENTEN / COMPONENTI / COMPONENTES / КОМПОНЕНТЫ
ESTRUCTURAS / FRAMES / STRUCTURES / GESTELL / STRUTTURA / ESTRUTURA / ТЕЛЕЖКА С РАМОЙ

COD.	L x W x H (mm)	Kg-MAX 	Kg 
50093	725x613x1430	300	25
50088	1023x613x1430		28



ESPECIFICACIONES TÉCNICAS / TECHNICAL SPECIFICATION / DÉTAILS TECHNIQUES

2 ruedas fijas y 2 giratorias con freno / 2 fixed and 2 revolving with brake wheels / 2 roues fixes et 2 roues giratoires avec frein

MÉNSULAS / SHELVES / ÉTAGÈRES / KONSOLEN / MENSOLE / PRATELEIRAS / ПОЛКИ

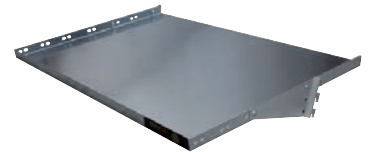
COD.	L x W x H (mm)	Kg-MAX 	Kg 	Válido para / Valid for / Valable pour
50095	657x220x30	50	2,3	50093
50094	657x420x30		3,4	
50090	955x320x30		4	
50089	955x600x30		7	

COMBINACIONES / COMBINATIONS / COMBINAISONS / KOMBINATIONEN / COMBINAZIONI / COMBINAÇÕES / КОМПЛЕКТЫ
725 MM
PROFUNDIDAD DE 220 MM / 220 MM DEPTH / PROFONDEUR DE 220 MM / 220 MM TIEFE / PROFONDITÀ DI 220 MM / PROFUNDIDADE DE 220 MM / ГЛУБИНА 220 MM

COD.	L x W x H (mm)			Kg 
50140	725x613x1430	2 x 50095	50093	29
50141		3 x 50095		32
50142		4 x 50095		34

ESPECIFICACIONES TÉCNICAS / TECHNICAL SPECIFICATION / DÉTAILS TECHNIQUES



2 ruedas fijas y 2 giratorias con freno / 2 fixed and 2 revolving with brake wheels / 2 roues fixes et 2 roues giratoires avec frein

Capacidad de carga estática total / Total static weight capacity / Capacité totale de charge statique

4"

300 kg

PROFUNDIDAD DE 420 MM / 420 MM DEPTH / PROFONDEUR DE 420 MM / 420 MM TIEFE / PROFONDITÀ DI 420 MM / PROFUNDIDADE DE 420 MM / ГЛУБИНА 420 MM

COD.	L x W x H (mm)			Kg 
50143	725x613x1430	2 x 50094	50093	32
50144		3 x 50094		35
50145		4 x 50094		38

ESPECIFICACIONES TÉCNICAS / TECHNICAL SPECIFICATION / DÉTAILS TECHNIQUES

2 ruedas fijas y 2 giratorias con freno / 2 fixed and 2 revolving with brake wheels / 2 roues fixes et 2 roues giratoires avec frein

Capacidad de carga estática total / Total static weight capacity / Capacité totale de charge statique



4"

300 kg



■ 1023 MM

■ PROFUNDIDAD DE 320 MM / 320 MM DEPTH / PROFONDEUR DE 320 MM / 320 MM TIEFE / PROFONDITÀ DI 320 MM / PROFUNDIDADE DE 320 MM / ГЛУБИНА 320 MM

COD.	L x W x H (mm)			
50149		2 x 50090		37
50150	1023x613x1430	3 x 50090	50088	41
50151		4 x 50090		45



ESPECIFICACIONES TÉCNICAS / TECHNICAL SPECIFICATION / DÉTAILS TECHNIQUES

2 ruedas fijas y 2 giratorias con freno / 2 fixed and 2 revolving with brake wheels / 2 roues fixes et 2 roues giratoires avec frein 4"

Capacidad de carga estática total / Total static weight capacity / Capacité totale de charge statique 300 kg



■ PROFUNDIDAD DE 600 MM / 600 MM DEPTH / PROFONDEUR DE 600 MM / 600 MM TIEFE / PROFONDITÀ DI 600 MM / PROFUNDIDADE DE 600 MM / ГЛУБИНА 600 MM

COD.	L x W x H (mm)			
50152		2 x 50089		42
50153	1023x613x1430	3 x 50089	50088	49
50154		4 x 50089		55

ESPECIFICACIONES TÉCNICAS / TECHNICAL SPECIFICATION / DÉTAILS TECHNIQUES

2 ruedas fijas y 2 giratorias con freno / 2 fixed and 2 revolving with brake wheels / 2 roues fixes et 2 roues giratoires avec frein 4"

Capacidad de carga estática total / Total static weight capacity / Capacité totale de charge statique 300 kg

COFRES PORTAHERRAMIENTAS DE SUPERFICIES INOX* / INOX SURFACE TOOL CHEST* / COFFRE À TIROIRS AVEC SURFACE INOX* / WERKSTATTKASTEN MIT INOX OBERFLÄCHE* / CASSETTI PORTAUTENSILI DI SUPERFICI INOX* / BAÚ PORTA-FERRAMENTAS DE SUPERFÍCIE INOX* / ПОРТАТИВНЫЕ ЯЩИКИ С ПОКРЫТИЕМ ИЗ НЕРЖАВЕЮЩЕЙ СТАЛИ*

■ 680 x 470 x 485

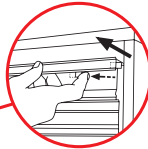

Sistema antivuelco con botón de seguridad de apertura individual por bandeja
Anti-overturn system with individual safety open button in each tray
Système anti-renversement avec bouton de sécurité d'ouverture individuelle par tiroir

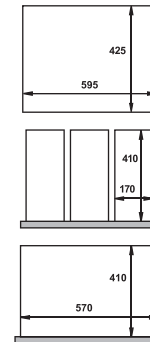
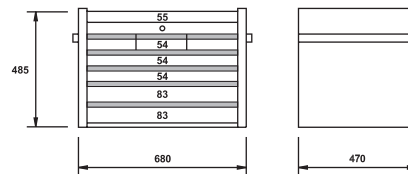

COD.	L x W x H (mm)	Material estructura / Material structure / Structure matériaux	
51560	680 x 470 x 485	Inox 430	45,5

INOX

ESPECIFICACIONES TÉCNICAS / TECHNICAL SPECIFICATION / DÉTAILS TECHNIQUES

Material* / Material* / Matière*	Exterior: 100% INOX - Interior: Acero pintado / Exterior 100% INOX - Interior: Painted Steel / Extérieur 100% INOX - Intérieur: Acier peint
Cajones con rodamientos / Ball-bearing slides / Tiroirs à roulement	7
Tapa con doble pistón neumático / Double pneumatic absorber equipped lid / Couvercle avec double piston pneumatique	●
Capacidad cajones 170,5 x 410 x 54 mm / Capacity in 170,5 x 410 x 54mm drawers / Capacité des tiroirs de 170,5 x 410 x 54 mm	15 kg
Capacidad cajones 570 x 410 x 54 mm / Capacity in 570 x 410 x 54 mm drawers / Capacité des tiroirs de 570 x 410 x 54 mm	25 kg
Capacidad cajones de altura 83 mm / Capacity in 83 mm height drawers / Capacité des tiroirs de 83 mm de haut	25 kg
Capacidad de carga estática total / Total static weight capacity / Capacité totale de charge statique	150 kg
Sistema de cierre centralizado / Central locking system / Système de fermeture centralisée	●
Asa lateral reforzada / Reinforced side handle / Poignées latérale renforcée	●
Sistema antivuelco en cada bandeja / Anti-overturn system in each drawers / Système anti-renversement dans chaque tiroir	●

1056 x 470 x 576

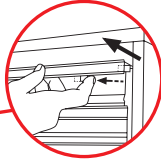

Sistema antivuelco con botón de seguridad de apertura individual por bandeja
 Anti-overturn system with individual safety open button in each tray
 Système anti-renversement avec bouton de sécurité d'ouverture individuelle par tiroir

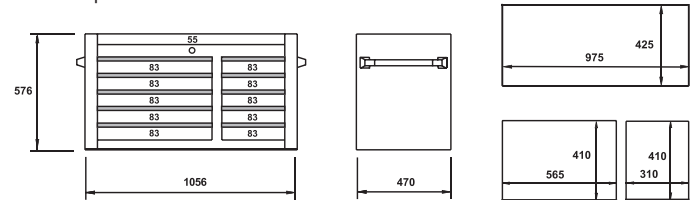

COD.	L x W x H (mm)	Material estructura / Material structure / Structure matériaux	Kg
51562	1056 x 470 x 576	Inox 430	95

INOX

ESPECIFICACIONES TÉCNICAS / TECHNICAL SPECIFICATION / DÉTAILS TECHNIQUES

Material* / Material* / Matière*	Exterior: 100% INOX - Interior: Acero pintado / Exterior 100% INOX - Interior: Painted Steel / Extérieur 100% INOX - Intérieur: Acier peint
Cajones con rodamientos / Ball-bearing slides / Tiroirs à roulement	10
Capacidad cajones de altura 83 mm / Capacity in 83 mm height drawers / Capacité des tiroirs de 83 mm de haut	25 kg
Capacidad de carga estática total / Total static weight capacity / Capacité totale de charge statique	200 kg
Sistema de cierre centralizado / Central locking system / Système de fermeture centralisée	●
Asa lateral reforzada / Reinforced side handle / Poignées latérale renforcée	●
Sistema antivuelco en cada bandeja / Anti-overturn system in each drawers / Système anti-renversement dans chaque tiroir	●

COFRE PORTAHERRAMIENTAS / TOOL CHEST / COFFRE À TIROIRS / WERKSTATT KASTEN MIT SCHUBLADEN / CASSETTIERE PORTAUTENSILI / BAÚS DE FERRAMENTAS / ЯЩИКИ ДЛЯ ИНСТРУМЕНТА

660 x 320 x 365

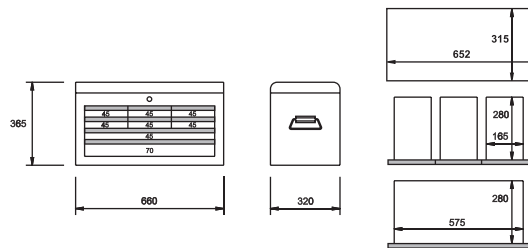

COD.	L x W x H (mm)	Kg	Color / Colour / Couleur
51011	660 x 320 x 365	24	
51480			
51492			
51504			

ESPECIFICACIONES TÉCNICAS / TECHNICAL SPECIFICATION / DÉTAILS TECHNIQUES

8 cajones con rodamientos / 8 ball-bearing slides / 8 tiroirs à roulement	●
Cerradura con llave / Key lock / Serrure avec clé	●
Asas laterales / Lateral handles / Anses latérales	●

■ 730 x 475 x 475





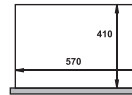
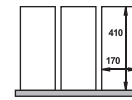
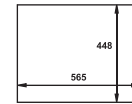
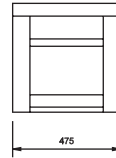
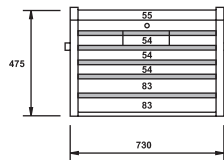

Sistema antivuelco con botón de seguridad de apertura individual por bandeja

Anti-overtum system with individual safety open button in each tray

Système anti-renversement avec bouton de sécurité d'ouverture individuelle par tiroir



COD.	L x W x H (mm)	Kg	Color / Colour / Couleur
51075	730 x 475 x 475	47	
51490			
51502			
51514			

ESPECIFICACIONES TÉCNICAS / TECHNICAL SPECIFICATION / DÉTAILS TECHNIQUES

7 cajones con rodamientos / 7 ball-bearing slides / 7 tiroirs à roulement	●
Estructura reforzada / Reinforced heavy duty structure / Structure renforcée	●
Sistema antivuelco en cada bandeja / Anti-overtum system in each drawers / Système anti-renversement dans chaque tiroir	●
Sistema de cierre centralizado / Central locking system / Système de fermeture centralisée	●
Cofre: Capacidad cajones de 570 x 410 x 54 mm / Chest: Capacity in 570 x 410 x 54 mm drawers / Coffre: Capacité des tiroirs de 570 x 410 x 54 mm	8 kg
Cofre: Capacidad cajones de 170 x 410 x 54 mm / Chest: Capacity in 170 x 410 x 54 mm drawers / Coffre: Capacité des tiroirs de 170 x 410 x 54 mm	5 kg
Capacidad de carga estática total / Total static weight capacity / Capacité totale de charge statique	60 kg
Capacidad cajones de altura 55 mm / Capacity in 55 mm height drawers / Capacité des tiroirs de 55 mm de haut	9 kg
Capacidad cajones de altura 85 mm / Capacity in 85 mm height drawers / Capacité des tiroirs de 85 mm de haut	10 kg
Asas laterales / Lateral handles / Anses latérales	●

EGA Master

ART IN INNOVATION

■ 1434 × 560 × 645



Sistema antivuelco con barra longitudinal de seguridad de apertura individual por bandeja
Anti-ouvert system with individual safety open longitudinal bar in each tray
 Système anti-renversement avec barre longitudinale de sécurité d'ouverture individuelle par tiroir

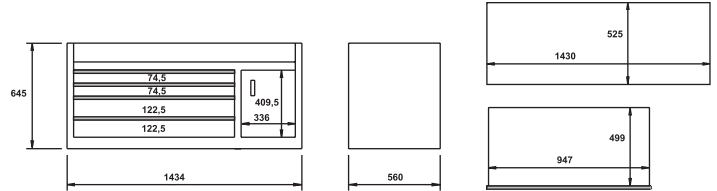

COD.	L x W x H (mm)	Kg	Color / Colour / Couleur
51072	1434 x 560 x 645	101	
51488			
51500			
51512			

ESPECIFICACIONES TÉCNICAS / TECHNICAL SPECIFICATION / DÉTAILS TECHNIQUES

4 cajones con rodamientos y armario / 4 drawer with ball bearings and 1 closet / 4 tiroirs à roulement et une armoire	●
Capacidad cajones de altura 74,5 mm / Capacity in 74,5 mm height drawers / Capacité des tiroirs de 74,5 mm de haut	30 kg
Capacidad cajones de altura 122,5 mm / Capacity in 122,5 mm height drawers / Capacité des tiroirs de 122,5 mm de haut	40 kg
Capacidad de carga estática total / Total static weight capacity / Capacité totale de charge statique	300 kg
Sistema antivuelco en cada bandeja / Anti-ouvert system in each drawers / Système anti-renversement dans chaque tiroir	●
Estructura reforzada / Reinforced heavy duty structure / Structure renforcée	●
Cerradura con llave / Key lock / Serrure avec clé	●

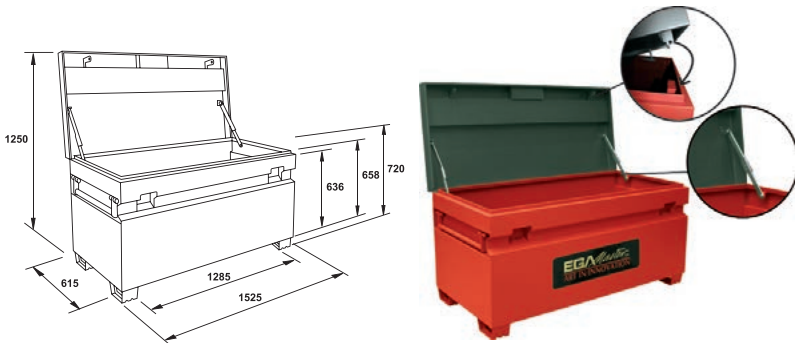

ARCONES METÁLICOS / METALLIC JOBSITE BOXES / COFFRES METALLIQUES / METALLARBEITSCHRÄNKE / CASSONI METALLICI / BAÚS METÁLICOS / МЕТАЛЛИЧЕСКИЕ ЯЩИКИ ДЛЯ ИНСТРУМЕНТОВ
1525 x 615 x 720

COD.	L x W x H (mm)	Espesor general (mm) / General thickness (mm) / Épaisseur générale (mm)	Espesor base (mm) / Base thickness (mm) / Épaisseur de base (mm)	Kg - MAX	Kg
50989	1525 x 615 x 720	1,5	2,5	300	74

ESPECIFICACIONES TÉCNICAS / TECHNICAL SPECIFICATION / DÉTAILS TECHNIQUES

- Patas especialmente diseñadas para transpalet / Prepared to be used with pallet truck / Coffres gerbables
- Fabricado en acero de alta calidad / Manufactured in high quality steel / Fabriqué en acier de haute qualité
- Cierre para candado / Prepared for padlock / Fermeture cadenas
- Asas laterales / Lateral handles / Anses latérales

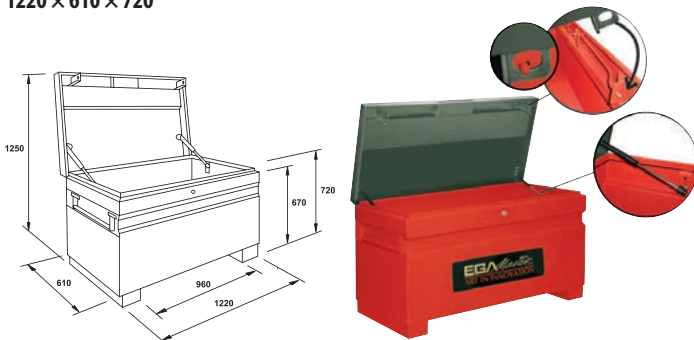
1220 x 610 x 720

COD.	L x W x H (mm)	Espesor general (mm) / General thickness (mm) / Épaisseur générale (mm)	Espesor base (mm) / Base thickness (mm) / Épaisseur de base (mm)	Kg - MAX	Kg
51046	1220 x 610 x 720	1,5	2,5	300	78

ESPECIFICACIONES TÉCNICAS / TECHNICAL SPECIFICATION / DÉTAILS TECHNIQUES

- Tapa con doble pistón neumático / Double pneumatic absorber equipped lid / Couvercle avec double pistón pneumatique
- Refuerzos laterales / Lateral reinforcement / Renforcements latéraux
- Cerradura en el centro del panel frontal con juego de dos llaves / Central safety lock (2 keys) / Serrure centrale (2 clés)
- Patas especialmente diseñadas para transpalet / Prepared to be used with pallet truck / Coffres gerbables
- Fabricado en acero de alta calidad / Manufactured in high quality steel / Fabriqué en acier de haute qualité
- Asas laterales / Lateral handles / Anses latérales

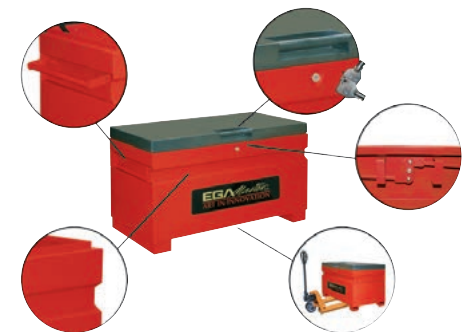

- Los arcones EGA Master están especialmente diseñados para poder estar contenidos el arcón de menor tamaño dentro del siguiente en dimensiones, esto es: / EGA Master jobsite boxes are specially designed to transport the smaller one into the next bigger one: / Les coffres EGA Master sont spécialement conçus pour contenir le coffre de dimension inférieure à l'intérieur:
- código 51048 dentro del código 51047. / code 51048 into code 51047. / code 51048 à l'intérieur du code 51047.
- código 51047 dentro del código 51046. / code 51047 into code 51046. / code 51047 à l'intérieur du code 51046.
- Esta ventaja permite reducir ampliamente los costes de transporte y ahorrar espacio de almacenamiento. / That allows reducing largely transport costs and saves storing space. / Cet avantage permet de réduire considérablement les coûts de transport et d'économiser l'espace de stockage.

■ 915 × 432 × 541

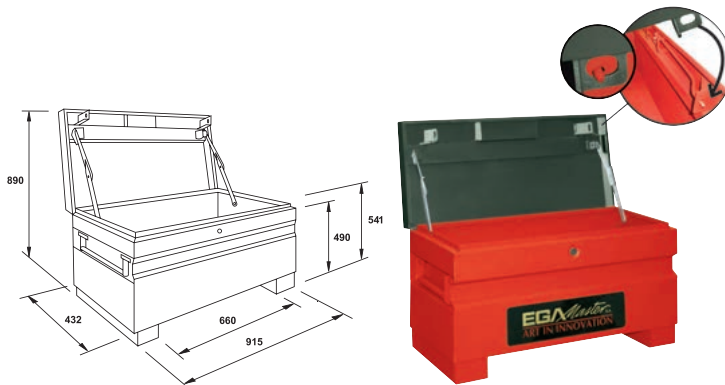

COD.	L x W x H (mm)	Espesor general (mm) / General thickness (mm) / Épaisseur générale (mm)	Espesor base (mm) / Base thickness (mm) / Épaisseur de base (mm)	Kg - MAX	Kg
51047	915 x 432 x 541	1,5	2,5	200	40

ESPECIFICACIONES TÉCNICAS / TECHNICAL SPECIFICATION / DÉTAILS TECHNIQUES

Refuerzos laterales / Lateral reinforcement / Renforcements latéraux	•
Cerradura en el centro del panel frontal con juego de dos llaves / Central safety lock (2 keys) / Serrure centrale (2 clés)	•
Patas especialmente diseñadas para transpalet / Prepared to be used with pallet truck / Coffres gerbables	•
Fabricado en acero de alta calidad / Manufactured in high quality steel / Fabriqué en acier de haute qualité	•
Asas laterales / Lateral handles / Anses latérales	•

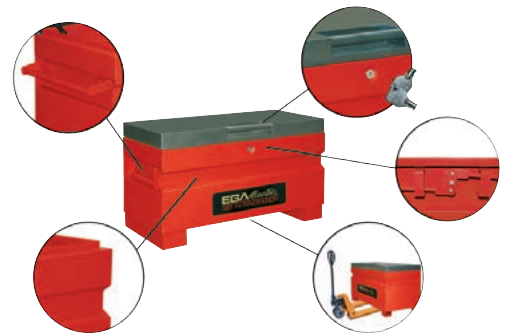

■ 720 × 315 × 282

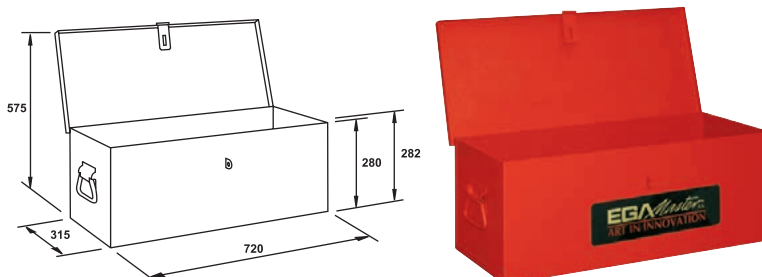

COD.	L x W x H (mm)	Espesor general (mm) / General thickness (mm) / Épaisseur générale (mm)	Kg - MAX	Kg
51048	720 x 315 x 282	1,5	80	13

ESPECIFICACIONES TÉCNICAS / TECHNICAL SPECIFICATION / DÉTAILS TECHNIQUES

Fabricado en acero de alta calidad / Manufactured in high quality steel / Fabriqué en acier de haute qualité	•
Cierre para candado / Prepared for padlock / Fermeture cadenas	•
Asas laterales / Lateral handles / Anses latérales	•



- Los arcones EGA Master están especialmente diseñados para poder estar contenidos el arcón de menor tamaño dentro del siguiente en dimensiones, esto es: / EGA Master jobsite boxes are specially designed to transport the smaller one into the next bigger one: / Les coffres EGA Master sont spécialement conçus pour contenir le coffre de dimension inférieure à l'intérieur:
- código 51048 dentro del código 51047. / code 51048 into code 51047. / code 51048 à l'intérieur du code 51047.
- código 51047 dentro del código 51046. / code 51047 into code 51046. / code 51047 à l'intérieur du code 51046.
- Esta ventaja permite reducir ampliamente los costes de transporte y ahorrar espacio de almacenamiento. / That allows reducing largely transport costs and saves storing space. / Cet avantage permet de réduire considérablement les coûts de transport et d'économiser l'espace de stockage.

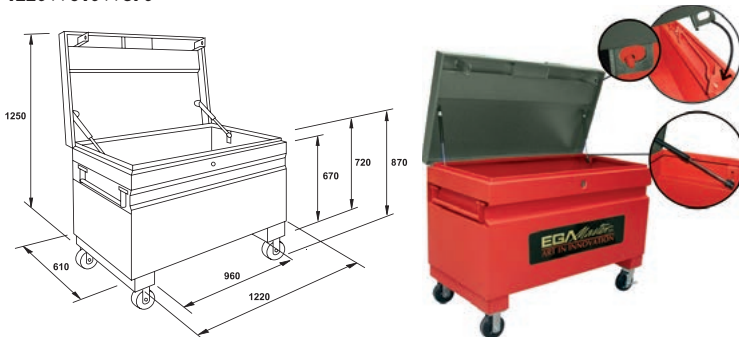

ARCONES METÁLICOS CON RUEDAS / METALLIC JOBSITE BOXES WITH ROLLERS / COFFRES METALLIQUES À ROUES / METALLARBEITSCHRÄNKE MIT RÄDER / CASSONI METALLICI CON ROUTE / BAÚS METÁLICOS COM RODAS / МЕТАЛЛИЧЕСКИЕ КОНТЕЙНЕРЫ ДЛЯ ХРАНЕНИЯ ИНСТРУМЕНТА НА КОЛЕСАХ
1220 × 610 × 870

COD.	L x W x H (mm)	Espesor general (mm) / General thickness (mm) / Épaisseur générale (mm)	Espesor base (mm) / Base thickness (mm) / Épaisseur de base (mm)	Kg-MAX	Kg
50991	1220 x 610 x 870	1,5	2,5	300	87

ESPECIFICACIONES TÉCNICAS / TECHNICAL SPECIFICATION / DÉTAILS TECHNIQUES

2 ruedas fijas y 2 giratorias con freno / 2 fixed and 2 revolving with brake wheels / 2 roues fixes et 2 roues giratoires avec frein	5" x 2"
Tapa con doble pistón neumático / Double pneumatic absorber equipped lid / Couvercle avec double piston pneumatique	●
Refuerzos laterales / Lateral reinforcement / Renforcements latéraux	●
Cerradura en el centro del panel frontal con juego de dos llaves / Central safety lock (2 keys) / Serrure centrale (2 clés)	●
Fabricado en acero de alta calidad / Manufactured in high quality steel / Fabriqué en acier de haute qualité	●
Asas laterales / Lateral handles / Anses latérales	●

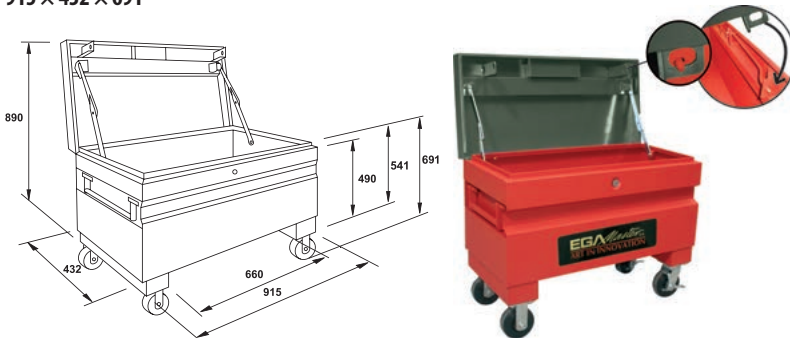
915 × 432 × 691

COD.	L x W x H (mm)	Espesor general (mm) / General thickness (mm) / Épaisseur générale (mm)	Espesor base (mm) / Base thickness (mm) / Épaisseur de base (mm)	Kg-MAX	Kg
50992	915 x 432 x 691	1,5	2,5	200	40

ESPECIFICACIONES TÉCNICAS / TECHNICAL SPECIFICATION / DÉTAILS TECHNIQUES

2 ruedas fijas y 2 giratorias con freno / 2 fixed and 2 revolving with brake wheels / 2 roues fixes et 2 roues giratoires avec frein	5" x 2"
Refuerzos laterales / Lateral reinforcement / Renforcements latéraux	●
Cerradura en el centro del panel frontal con juego de dos llaves / Central safety lock (2 keys) / Serrure centrale (2 clés)	●
Fabricado en acero de alta calidad / Manufactured in high quality steel / Fabriqué en acier de haute qualité	●
Asas laterales / Lateral handles / Anses latérales	●

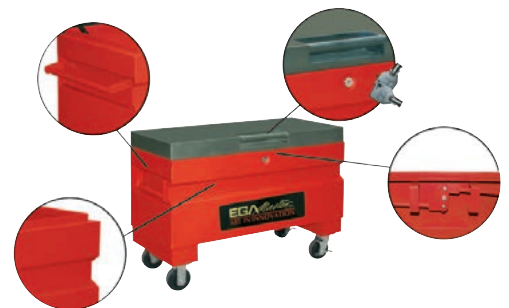

ARCONES GALVANIZADOS / GALVANIZED JOBSITE BOXES / COFFRES GALVANISÉS / VERZINKTE ARBEITS-KISTE / CASSONI GALVANIZZATI / BAÚS GALVANIZADOS / ИНСТРУМЕНТАЛЬНЫЙ ЯЩИК С ЗАЩИТНЫМ ПОКРЫТИЕМ

■ 1144 × 367 × 380



COD.	L x W x H (mm)	Espesor general (mm) / General thickness (mm) / Épaisseur générale (mm)	Kg - MAX	Kg
51078	1144 x 367 x 380	0,6	45	12,5

ESPECIFICACIONES TÉCNICAS / TECHNICAL SPECIFICATION / DÉTAILS TECHNIQUES

Fabricado en acero galvanizado de alta calidad / Manufactured in high quality galvanized steel / Fabriqué en acier galvanisé d'haute qualité

Cierre para candado / Prepared for padlock / Fermeture cadenas

Asas laterales / Lateral handles / Anses latérales

■ 759 × 327 × 250



COD.	L x W x H (mm)	Espesor general (mm) / General thickness (mm) / Épaisseur générale (mm)	Kg - MAX	Kg
51077	759 x 327 x 250	0,6	32	6,7

ESPECIFICACIONES TÉCNICAS / TECHNICAL SPECIFICATION / DÉTAILS TECHNIQUES

Fabricado en acero galvanizado de alta calidad / Manufactured in high quality galvanized steel / Fabriqué en acier galvanisé d'haute qualité

Cierre para candado / Prepared for padlock / Fermeture cadenas

Asas laterales / Lateral handles / Anses latérales

1 bandeja / 1 tray / 1 plateau

■ 555 × 230 × 210



COD.	L x W x H (mm)	Espesor general (mm) / General thickness (mm) / Épaisseur générale (mm)	Kg - MAX	Kg
51076	555 x 230 x 210	0,5	20	3,2

ESPECIFICACIONES TÉCNICAS / TECHNICAL SPECIFICATION / DÉTAILS TECHNIQUES

Fabricado en acero galvanizado de alta calidad / Manufactured in high quality galvanized steel / Fabriqué en acier galvanisé d'haute qualité

Cierre para candado / Prepared for padlock / Fermeture cadenas

Asas laterales / Lateral handles / Anses latérales

- Los arcones EGA Master están especialmente diseñados para poder estar contenidos el arcón de menor tamaño dentro del siguiente en dimensiones, esto es: / EGA Master jobsite boxes are specially designed to transport the smaller one into the next bigger one: / Les coffres EGA Master sont spécialement conçus pour contenir le coffre de dimension inférieure à l'intérieur.
- código 51076 dentro del código 51077. / code 51076 into code 51077. / code 51076 à l'intérieur du code 51077.
- código 51077 dentro del código 51078. / code 51077 into code 51078. / code 51077 à l'intérieur du code 51078.
- Esta ventaja permite reducir ampliamente los costes de transporte y ahorrar espacio de almacenamiento. / That allows reducing largely transport costs and saves storing space. / Cet avantage permet de réduire considérablement les coûts de transport et d'économiser l'espace de stockage.



MALETA DE ALUMINIO PORTAHERRAMIENTAS / ALUMINIUM TOOL CASE / MALLETTE PORTE-OUTILS / ALUMINIUMKOFFER ZUM ROLLEN / VALIGIA PORTAUTENSILI IN ALLUMINO / MALA DE ALUMINIO PORTAFERRAMENTAS / АЛЮМИНИЕВЫЙ ИНСТРУМЕНТАЛЬНЫЙ КЕЙС
1350 x 356 x 114

COD.	L x W x H (mm)	Kg - MAX	Kg
51055	1350 x 356 x 114	18	7,5

ESPECIFICACIONES TÉCNICAS / TECHNICAL SPECIFICATION / DÉTAILS TECHNIQUES

Cerradura con llave / Key lock / Serrure avec clé	●
Con cierres en zamak / Zinc alloy lockers / Casiers en alliage de zinc	●

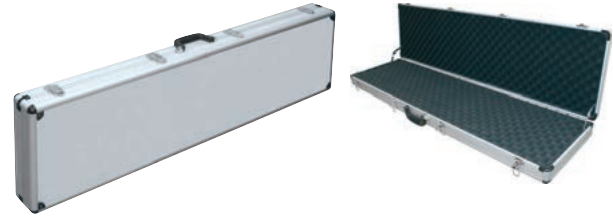
520 x 330 x 152

COD.	L x W x H (mm)	Kg - MAX	Kg
51056	520 x 330 x 152	13	3,6

ESPECIFICACIONES TÉCNICAS / TECHNICAL SPECIFICATION / DÉTAILS TECHNIQUE

Cerradura con llave / Key lock / Serrure avec clé	●
Con cierres en zamak / Zinc alloy lockers / Casiers en alliage de zinc	●

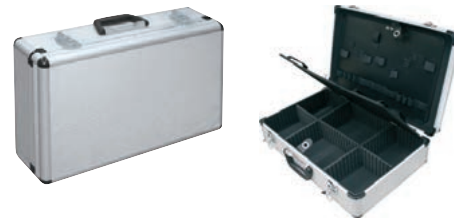
665 x 500 x 110

COD.	L x W x H (mm)	Kg - MAX	Kg
51054	665 x 500 x 110	10	3,4

365 x 240 x 75

COD.	L x W x H (mm)	Kg - MAX	Kg
51053	365 x 240 x 75	5	1,2

288 x 180 x 53

COD.	L x W x H (mm)	Kg - MAX	Kg
51079	288 x 180 x 53	5	0,6

250 x 145 x 53

COD.	L x W x H (mm)	Kg - MAX	Kg
51071	250 x 145 x 53	5	0,4

450 X 300 X 85

COD.	L x W x H (mm)	Kg - MAX	Kg
50974	450 x 300 x 85	5	1,5



■ 455 × 205 × 320

COD.	L x W x H (mm)	Kg
51012	455 x 205 x 320	4,0

ESPECIFICACIONES / SPECIFICATION / DÉTAILS

Ruedas / <i>Wheels</i> / Roues	●
Capacidad / <i>Capacity</i> / Capacité	15 kg
Cerradura de combinación / <i>Number combination lock</i> / Fermeture sécurisée par combinaison	●
Asa telescópica / <i>Telescopic handle</i> / Anse télescopique	●



■ MALETA PORTAHERRAMIENTAS / TOOL CASE / MALLETE PORTE-OUTILS / WERKZEUGKOFFER / VALIGIA PORTAUTENSILI / MALA PORTAFERRAMENTAS / Кейс для инструмента

■ 470 × 355 × 160

COD.	L x W x H (mm)	Kg
51010	470 x 355 x 160	3,2

ESPECIFICACIONES / SPECIFICATION / DÉTAILS

Capacidad / <i>Capacity</i> / Capacité	15 kg
ABS extra resistente / <i>Extra-resistant ABS</i> / ABS extra-résistant	●
Cerradura con llave / <i>Key lock</i> / Serrure avec clé	●



■ 470 × 355 × 210

COD.	L x W x H (mm)	Kg
50993	470 x 355 x 220	5,0

ESPECIFICACIONES / SPECIFICATION / DÉTAILS

Ruedas / <i>Wheels</i> / Roues	●
Capacidad / <i>Capacity</i> / Capacité	15 kg
ABS extra resistente / <i>Extra-resistant ABS</i> / ABS extra-résistant	●
Cerradura con llave / <i>Key lock</i> / Serrure avec clé	●
Cerradura de combinación / <i>Number combination lock</i> / Fermeture sécurisée par combinaison	●
Resistencia / <i>Resistance</i> / Résistance	>90 kg
Asa telescópica / <i>Telescopic handle</i> / Anse télescopique	560 mm



BE SAFE...BE EFFICIENT

CARROS PORTAMALETAS / PLASTIC TOOL BOXES WITH TROLLEY / CHARIOTS PORTE-MALETTES / WERKZEUGKÄSTEN AUS KUNSTSTOFF MIT WAGEN / TROLLEY PORTAUTENSILI A 2 MODULI / CAIXAS DE FERRAMENTA COM TROLLEY / КОМПЛЕКТ ПЛАСТИКОВЫХ КЕЙСОВ НА ТЕЛЕЖКЕ
470 × 290 × 630

COD.	L x W x H (mm)	Kg
50968	470 x 290 x 630	4,1

ESPECIFICACIONES / SPECIFICATION / DÉTAILS	
Ruedas / Wheels / Roues	●
Capacidad / Capacity / Capacité	60 litros
Mat: PP	●
2 asas plegables / 2 folding handle / 2 anses pliables	●
1 bandeja / 1 tray / 1 plateau	●

500 × 410 × 770

COD.	L x W x H (mm)	Kg
50966	500 x 410 x 770	15

ESPECIFICACIONES / SPECIFICATION / DÉTAILS	
Cajones y tapa transparente / Drawer and transparent cover / Tiroir avec couvercle transparent	Poliestireno (PS) / Polystyrene (PS) / Polystyrène (PS)
1 maleta + 1 maleta con cajón / 1 case + 1 drawer case / 1 mallette + 1 mallette avec tiroir	●
Ruedas / Wheels / Roues	●
Capacidad / Capacity / Capacité	40 kg
Estuche / Case / Étui	Dos de: 430 x 370 x 85 mm - Uno de: 430 x 370 x 55 mm
Cajas / Boxes / Caisses	55 x 39 x 47 mm (10 pcs) & 79 x 55 x 47 mm (10 pcs) & 109 x 79 x 47 mm (5 pcs) & 79 x 55 x 76 mm (5 pcs) & 109 x 79 x 76 mm (6 pcs) & 157 x 109 x 76 mm (2 pcs)
Mat: PP	●

MALETAS ROBUST / ROBUST CASES / VALISES ROBUST / ROBUSTER KOFFER / VALIGIE ROBUST / MALAS ROBUST / УДАРОПРОЧНЫЕ КЕЙСЫ
MALETAS ROBUST CON RUEDAS / ROBUST CASES WITH TROLLEY / VALISES ROBUST À ROULETTES / ROBUSTER KOFFER MIT ROLLER / VALIGIE ROBUST CON RUOTE / TROLLEY ROBUST / УДАРОПРОЧНЫЙ КЕЙС С ТЕЛЕЖКОЙ
581 × 381 × 455

COD.	L x W x H (mm)	Kg	Grado de protección / Degree of protection / Grade de protection
58594	581 x 381 x 455	15	IP67
58605		18	-

ESPECIFICACIONES / SPECIFICATION / DÉTAILS	
Bandeja portaherramientas / Tool tray / Plateau porte-outils	8 × 58620
Grado de protección / Ingress protection / Grade de protection	58594 IP67 58605 -
Ruedas / Wheels / Roues	●

COD.	L x W x H (mm)	Kg	Grado de protección / Degree of protection / Grade de protection
58595	581 x 381 x 455	14	IP67
58606		18	-

ESPECIFICACIONES / SPECIFICATION / DÉTAILS	
Bandeja portaherramientas / Tool tray / Plateau porte-outils	6 × 58620 + 1 × 58621
Grado de protección / Ingress protection / Grade de protection	58595 IP67 58606 -
Ruedas / Wheels / Roues	●

COD.	L x W x H (mm)	Kg	Grado de protección / Degree of protection / Grade de protection
58596	581 x 381 x 455	14	IP67
58607		17	-

ESPECIFICACIONES / SPECIFICATION / DÉTAILS

Bandeja portaherramientas / Tool tray / Plateau porte-outils 4 x 58620 + 2 x 58621

Grado de protección / Ingress protection / Grade de protection

58596 IP67

58607 -

Ruedas / Wheels / Roues ●

COD.	L x W x H (mm)	Kg	Grado de protección / Degree of protection / Grade de protection
58597	581 x 381 x 455	14	IP67
58608		17	-

ESPECIFICACIONES / SPECIFICATION / DÉTAILS

Bandeja portaherramientas / Tool tray / Plateau porte-outils 2 x 58620 + 3 x 58621

Grado de protección / Ingress protection / Grade de protection

58597 IP67

58608 -

Ruedas / Wheels / Roues ●

COD.	L x W x H (mm)	Kg	Grado de protección / Degree of protection / Grade de protection
58598	581 x 381 x 455	13	IP67
58609		17	-

ESPECIFICACIONES / SPECIFICATION / DÉTAILS

Bandeja portaherramientas / Tool tray / Plateau porte-outils 4 x 58621

Grado de protección / Ingress protection / Grade de protection

58598 IP67

58609 -

Ruedas / Wheels / Roues ●

COD.	L x W x H (mm)	Kg	Grado de protección / Degree of protection / Grade de protection
58599	581 x 381 x 455	14	IP67
58610		17	-

ESPECIFICACIONES / SPECIFICATION / DÉTAILS

Bandeja portaherramientas / Tool tray / Plateau porte-outils 5 x 58620 + 1 x 58622

Grado de protección / Ingress protection / Grade de protection

58599 IP67

58610 -

Ruedas / Wheels / Roues ●

COD.	L x W x H (mm)	Kg	Grado de protección / Degree of protection / Grade de protection
58600	581 x 381 x 455	13	IP67
58611		17	-

ESPECIFICACIONES / SPECIFICATION / DÉTAILS

Bandeja portaherramientas / Tool tray / Plateau porte-outils 2 x 58620 + 2 x 58622

Grado de protección / Ingress protection / Grade de protection

58600 IP67

58611 -

Ruedas / Wheels / Roues ●

COD.	L x W x H (mm)	Kg	Grado de protección / Degree of protection / Grade de protection
58601	581 x 381 x 455	13	IP67
58612		16	-

ESPECIFICACIONES / SPECIFICATION / DÉTAILS

Bandeja portaherramientas / Tool tray / Plateau porte-outils 1 x 58621 + 2 x 58622

Grado de protección / Ingress protection / Grade de protection

58601 IP67

58612 -

Ruedas / Wheels / Roues ●

COD.	L x W x H (mm)	Kg	Grado de protección / Degree of protection / Grade de protection
58602	581 x 381 x 455	13	IP67
58613		17	-

ESPECIFICACIONES / SPECIFICATION / DÉTAILS

Bandeja portaherramientas / Tool tray / Plateau porte-outils 1 x 58620 + 2 x 58621 + 1 x 58622

Grado de protección / Ingress protection / Grade de protection

58602 IP67

58613 -

Ruedas / Wheels / Roues ●

COD.	L x W x H (mm)	Kg	Grado de protección / Degree of protection / Grade de protection
58603	581 x 381 x 455	14	IP67
58614		17	-

ESPECIFICACIONES / SPECIFICATION / DÉTAILS

Ruedas / Wheels / Roues ●

Bandeja portaherramientas / Tool tray / Plateau porte-outils 3 x 58620 + 1 x 58621 + 1 x 58622

Grado de protección / Ingress protection / Grade de protection

58603 IP67

58614 -

■ REPUESTOS / SPARE PARTS / RECHANGES / ERSATZTEILE / ACCESSORI / ACESSORIOS / ЗАПАСНЫЕ ЧАСТИ

■ BANDEJAS / TRAYS / PLATEAUX / ABLAGEKASTEN / PANNELLO / TABULEIROS / ПОДДОНЫ



COD.	L x W x H (mm)
58620	467 x 255 x 30

COD.	L x W x H (mm)
58621	467 x 255 x 60

COD.	L x W x H (mm)
58622	467 x 255 x 95

■ 546 × 347 × 247

COD.	L x W x H (mm)	Kg	Grado de protección / Degree of protection / Grade de protection
58591	546 × 347 × 247	6,5	IP67

ESPECIFICACIONES TÉCNICAS / TECHNICAL SPECIFICATION / DÉTAILS TECHNIQUES

Bandeja portaherramientas / Tool tray / Plateau porte-outils	-
Grado de protección / Ingress protection / Grade de protection	IP67
Ruedas / Wheels / Roues	●



■ 670 × 510 × 372

COD.	L x W x H (mm)	Kg	Grado de protección / Degree of protection / Grade de protection
58592	670 × 510 × 372	10,5	IP67

ESPECIFICACIONES TÉCNICAS / TECHNICAL SPECIFICATION / DÉTAILS TECHNIQUES

Bandeja portaherramientas / Tool tray / Plateau porte-outils	-
Grado de protección / Ingress protection / Grade de protection	IP67
Ruedas / Wheels / Roues	●



■ MALETAS ROBUST / ROBUST CASES / VALISES ROBUST / ROBUSTER KOFFER / VALIGIE ROBUST / MALAS ROBUST / УДАРОПРОЧНЫЕ КЕЙСЫ

■ 445 × 345 × 125

COD.	L x W x H (mm)	Kg	Grado de protección / Degree of protection / Grade de protection
58590	445 × 345 × 125	3,4	IP67

ESPECIFICACIONES TÉCNICAS / TECHNICAL SPECIFICATION / DÉTAILS TECHNIQUES

Bandeja portaherramientas / Tool tray / Plateau porte-outils	-
Grado de protección / Ingress protection / Grade de protection	IP67
Ruedas / Wheels / Roues	-



MALETA ABS APILABLE E INDESTRUCTIBLE / ABS TOOL CASE STACKABLE AND INDESTRUCTIBLE / VALISE ABS EMPILABLE ET INDESTRUCTIBLE / ABS WERKZEUGKISTE STAPELBAR UND UNVERWÜSTLICH / ABS CASSETTE PORTAUNTENSILI IMPILABILE INDISTRUTTIBILE / MALAS ABS MODULAR ES E INDESTRUTÍVEIS / ПРОТИВОУДАРНЫЙ ЯЩИК ШТАБИЛИРУЕМЫЙ ПЛАСТМАССА АБС

COD.	L x W x H (mm)	Kg
50994	464 x 335 x 142	2,2

ESPECIFICACIONES TÉCNICAS / TECHNICAL SPECIFICATION / DÉTAILS TECHNIQUES

Capacidad / Capacity / Capacité	60 kg
ABS extra resistente / Extra-resistant ABS / ABS extra-résistant	Hasta 90 kg / Up to 90 kg / Jusqu'à 90 kg
Mat: PP	●
Apilables / Stackables / Empilables	●
Auto-basculante / Self-balancing / Auto-basculant	●
Ergonómicamente diseñada para que el agua y el polvo resbalen por el rail / Construction will guide rain and dust away / Ergonomiquement conçue pour que l'eau et la poussière glisse sur le rebord	●



COD.	L x W x H (mm)	Kg
50995	464 x 335 x 212	2,5

ESPECIFICACIONES TÉCNICAS / TECHNICAL SPECIFICATION / DÉTAILS TECHNIQUES

Capacidad / Capacity / Capacité	60 kg
ABS extra resistente / Extra-resistant ABS / ABS extra-résistant	Hasta 90 kg / Up to 90 kg / Jusqu'à 90 kg
Apilables / Stackables / Empilables	●
Auto-basculante / Self-balancing / Auto-basculant	●
Ergonómicamente diseñada para que el agua y el polvo resbalen por el rail / Construction will guide rain and dust away / Ergonomiquement conçue pour que l'eau et la poussière glisse sur le rebord	●



COD.	L x W x H (mm)	Kg
50996	464 x 335 x 362	3,2

ESPECIFICACIONES TÉCNICAS / TECHNICAL SPECIFICATION / DÉTAILS TECHNIQUES

Capacidad / Capacity / Capacité	60 kg
ABS extra resistente / Extra-resistant ABS / ABS extra-résistant	Hasta 90 kg / Up to 90 kg / Jusqu'à 90 kg
Apilables / Stackables / Empilables	●
Auto-basculante / Self-balancing / Auto-basculant	●
Ergonómicamente diseñada para que el agua y el polvo resbalen por el rail / Construction will guide rain and dust away / Ergonomiquement conçue pour que l'eau et la poussière glisse sur le rebord	●

ACCESORIOS / ACCESSORIES / ACCESSOIRES / ERSATZTEILE / ACCESSORI / ACCESSORIOS / ЗАПАСНЫЕ ЧАСТИ

COD.	Descripción / Description / Description
50981	Superior fijo / Fixed upper / Supérieur fixe
50982	Inferior móvil / Movable lower / Inférieur amovible

MALETA ABS APILABLE E INDESTRUCTIBLE CON PANELES / ABS TOOL CASE STACKABLE AND INDESTRUCTIBLE WITH PANELS / VALISE ABS EMPILABLE ET INDESTRUCTIBLE AVEC PANNEAUX / ABS STAPELBARE UND ZERSTÖRBARE WERKZEUGKISTEN MIT EINSÄTZE / CASSETTE IN ABS IMPILABILI E INDISTRUTTIBILI CON PANNELLI / MALA ABS EMPILHÁVEL E INDESTRUTÍVEL COM PAINÉIS / ЧЕМОДАН ABS НАРАЩИВАЕМЫЙ И НЕРУШИМЫЙ С ПАНЕЛЯМИ

COD.	L x W x H (mm)		
50983	464 x 335 x 142	1	2,55

ESPECIFICACIONES TÉCNICAS / TECHNICAL SPECIFICATION / DÉTAILS TECHNIQUES

Capacidad / Capacity / Capacité	60 kg
ABS extra resistente / Extra-resistant ABS / ABS extra-résistant	Hasta 90 kg / Up to 90 kg / Jusqu'à 90 kg
Panel / Panel / Panneau	Superior: cod. 50981 Inferior: cod. 50982 / Upper: cod. 50981 Lower: cod. 50982 / Supérieur: cod. 50981 Inférieur: cod. 50982
Apilables / Stackables / Empilables	●
Auto-basculante / Self-balancing / Auto-basculant	●
Ergonómicamente diseñada para que el agua y el polvo resbalen por el rail / Construction will guide rain and dust away / Ergonomiquement conçu pour que l'eau et la poussière glisse sur le rebord	●





COD.	L x W x H (mm)		
50984	464 x 335 x 212	1	3,05

ESPECIFICACIONES TÉCNICAS / TECHNICAL SPECIFICATION / DÉTAILS TECHNIQUES

Capacidad / Capacity / Capacité	60 kg
ABS extra resistente / Extra-resistant ABS / ABS extra-résistant	Hasta 90 kg / Up to 90 kg / Jusqu'à 90 kg
Panel / Panel / Panneau	Superior: cod. 50981 Inferior: cod. 50982 / Upper: cod. 50981 Lower: cod. 50982 / Supérieur: cod. 50981 Inférieur: cod. 50982
Apilables / Stackables / Empilables	●
Auto-basculante / Self-balancing / Auto-basculant	●
Ergonómicamente diseñada para que el agua y el polvo resbalen por el rail / Construction will guide rain and dust away / Ergonomiquement conçu pour que l'eau et la poussière glisse sur le rebord	●



COD.	L x W x H (mm)			
50985	464 x 335 x 362	1	2	5,05

CARACTERÍSTICAS / FEATURES / CARACTÉRISTIQUES

Posibilidad de incorporar más paneles en el fondo / Possibility to place more panels on the bottom / Possibilité d'incorporer plus de panneaux au fond

ESPECIFICACIONES TÉCNICAS / TECHNICAL SPECIFICATION / DÉTAILS TECHNIQUES

Capacidad / Capacity / Capacité	60 kg
ABS extra resistente / Extra-resistant ABS / ABS extra-résistant	Hasta 90 kg / Up to 90 kg / Jusqu'à 90 kg
Panel / Panel / Panneau	Superior: cod. 50981 Inferior: cod. 50982 / Upper: cod. 50981 Lower: cod. 50982 / Supérieur: cod. 50981 Inférieur: cod. 50982
Apilables / Stackables / Empilables	●
Auto-basculante / Self-balancing / Auto-basculant	●
Ergonómicamente diseñada para que el agua y el polvo resbalen por el rail / Construction will guide rain and dust away / Ergonomiquement conçu pour que l'eau et la poussière glisse sur le rebord	●



CARRO DE TRANSPORTE PARA MALETAS ABS APILABLES / TROLLEY FOR ABS STACKABLE TOOL CASES / CHARIOT POUR TRANSPORT DE VALISES ABS EMPILABLES / WAGEN FÜR STAPELBARE WERKZEUGKOFFER / CARRELLO PER TRASPORTO DI VALIGIE ABS IMPILABILI / CARRO DE TRANSPORTE PARA MALAS ABS EMPILHÁVEIS / ТЕЛЕЖКА ДЛЯ ПЛАСТИКОВЫХ ИНСТРУМЕНТАЛЬНЫХ ЯЩИКОВ

COD.	L x W x H (mm)	
50988	470 x 350 x 110	3,5

ESPECIFICACIONES TÉCNICAS / TECHNICAL SPECIFICATION / DÉTAILS TECHNIQUES

2 ruedas giratorias y 2 giratorias con freno / 2 revolving and 2 revolving with break wheels / 2 roues giratoires et 2 giratoires avec frein	●
Capacidad / Capacity / Capacité	200 kg



MALETA APILABLE / STACKABLE TOOL CASE / VALISE EMPILABLE / STAPELBARER WERKZEUGKOFFER / CASSETTO PORTAUTENSILI IMPILABILE / MALA EMPILHÁVEL / ШТАБЕЛИРУЕМЫЙ КЕЙС
■ 585 × 385 × 190

COD.	L x W x H (mm)	
58870	585x385x190	5,0

ESPECIFICACIONES TÉCNICAS / TECHNICAL SPECIFICATION / DÉTAILS TECHNIQUES

Apilables / Stackables / Empilables	●
Mat: PP	●
Capacidad / Capacity / Capacité	12 L

■ 585 × 385 × 320

COD.	L x W x H (mm)	
58871	585x385x320	5,5

ESPECIFICACIONES TÉCNICAS / TECHNICAL SPECIFICATION / DÉTAILS TECHNIQUES

Apilables / Stackables / Empilables	●
Mat: PP	●
Capacidad / Capacity / Capacité	38 L



■ 585 × 385 × 420

COD.	L x W x H (mm)	Kg
58872	585x385x420	6,5

ESPECIFICACIONES TÉCNICAS / TECHNICAL SPECIFICATION / DÉTAILS TECHNIQUES

Apilables / Stackables / Empilables	●
Mat: PP	●
Capacidad / Capacity / Capacité	52 L



■ PLATAFORMA PARA MALETAS APILABLES / PLATFORM FOR STOCKABLE CASES / PLATEFORME POUR MALETTES EMPILABLES / PLATTFORM FÜR STAPELBARE KOFFER / PIATTAFORMA PER CASSETTE PORTAUNTENSILI IMPILABILI / PLATAFORMA PARA MALAS MODULARES / ПЛАТФОРМА ДЛЯ ШТАБЕЛИРУЕМЫХ кейсов

COD.	L x W x H (mm)	Kg
58873	745x510x180	4,5

ESPECIFICACIONES TÉCNICAS / TECHNICAL SPECIFICATION / DÉTAILS TECHNIQUES

Apilables / Stackables / Empilables	●
Mat: PP	●
2 ruedas fijas y 2 giratorias con freno / 2 fixed and 2 revolving with brake wheels / 2 roues fixes et 2 roues giratoires avec frein	●



■ JUEGO DE MALETAS APILABLES CON PLATAFORMA / STOCKABLE CASE SET WITH PLATFORM / JEU DE MALETTES EMPILABLES AVEC PLATEFORME / STAPELBARE KOFFER MIT PLATTFORM / KIT CASSETTE PORTAUNTENSILI IMPILABILI CON PIATTAFORMA / CONJUNTO DE MALAS MODULARES COM PLATAFORMA / КОМПЛЕКТ кейсов на платформе

COD.	L x W x H (mm)	Kg
58874	1000x745x510	22



EGGA Master

ART IN INNOVATION

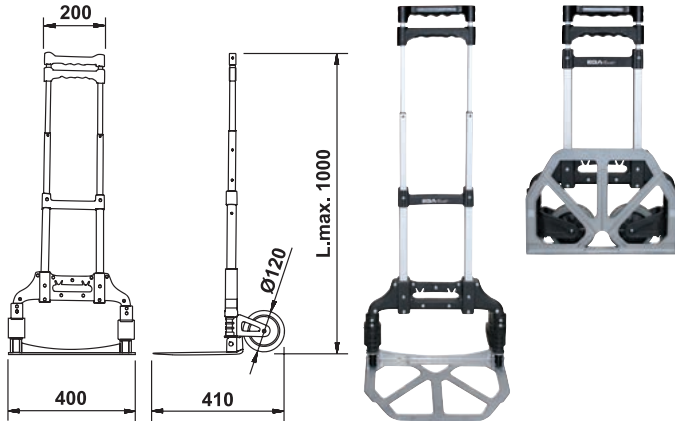
CARRO DE TRANSPORTE UNIVERSAL / UNIVERSAL TROLLEY / CHARIOT POUR TRANSPORT UNIVERSEL / UNIVERSALWAGEN / CARRELLO PER TRASPORTO UNIVERSALE / CARRO DE TRANSPORTE MANUAL / УНИВЕРСАЛЬНАЯ ТЕЛЕЖКА





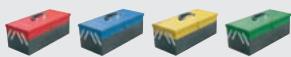

COD.	L x W x H (mm)		
50986	1000 x 400 x 410	630 x 390 x 60	3,15

ESPECIFICACIONES TÉCNICAS / TECHNICAL SPECIFICATION / DÉTAILS TECHNIQUES

2 ruedas / 2 wheels / 2 roues	●
Capacidad / Capacity / Capacité	60 kg
Material / Material / Matière	Aluminio / Aluminum / Aluminium
Cuerda para amarre / Mooring rope / Corde pour amarrage	●





CAJAS DE HERRAMIENTAS / TOOL BOXES / CAISSES À OUTILS / WERKZEUGKASTEN / CASSETTE PORTAUTENSILI / CAIXAS DE FERRAMENTAS / ЯЩИКИ ДЛЯ ИНСТРУМЕНТА

Disponible en 4 colores
 Available in 4 colors
 Disponible en 4 couleurs

COD.	L x W x H (mm)		Color / Colour / Couleur
51022	466 x 210 x 170	3,0	
51481			
51493			
51505			







ESPECIFICACIONES TÉCNICAS / TECHNICAL SPECIFICATION / DÉTAILS TECHNIQUES

Capacidad / Capacity / Capacité	20 kg
Elementos / Compartments / Cases	3

COD.	L x W x H (mm)		Color / Colour / Couleur
51023	495 x 200 x 293	4,5	
51482			
51494			
51506			

ESPECIFICACIONES TÉCNICAS / TECHNICAL SPECIFICATION / DÉTAILS TECHNIQUES

Capacidad / Capacity / Capacité	25 kg
Elementos / Compartments / Cases	5

COD.	L x W x H (mm)		Color / Colour / Couleur
51038	404 x 200 x 195	3,3	
51485			
51497			
51509			

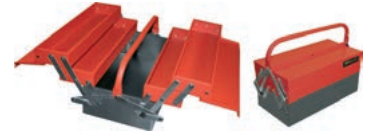

ESPECIFICACIONES TÉCNICAS / TECHNICAL SPECIFICATION / DÉTAILS TECHNIQUES	
Capacidad / Capacity / Capacité	20 kg
Elementos / Compartments / Cases	5

COD.	L x W x H (mm)	
64648	550 x 245 x 250	4,0

ESPECIFICACIONES TÉCNICAS / TECHNICAL SPECIFICATION / DÉTAILS TECHNIQUES	
Capacidad / Capacity / Capacité	20 kg
Elementos / Compartments / Cases	1



COD.	L x W x H (mm)	
86280	305 x 50 x 45	0,25
86281	315 x 80 x 40	0,30
86282	410 x 75 x 65	0,56
86283	370 x 100 x 60	0,75
86284	280 x 130 x 75	1,00
86285	540 x 95 x 75	1,25
86286	305 x 45 x 40	0,20
86287	310 x 85 x 40	0,30
86288	380 x 65 x 60	0,65
86289	380 x 100 x 60	0,75
86290	280 x 130 x 75	1,00
86291	540 x 95 x 75	1,25

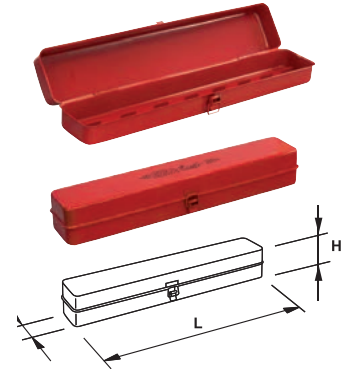

COD.	L x W x H (mm)	CAP. (kg)	
51058	400 x 206 x 188	15	955

ESPECIFICACIONES TÉCNICAS / TECHNICAL SPECIFICATION / DÉTAILS TECHNIQUES	
Mat: PP	●
Compartimentos / Compartments / Cases	8
1 bandeja / 1 tray / 1 plateau	●



COD.	L x W x H (mm)	CAP. (kg)	Kg
51059	480 x 258 x 255	30	2,22

ESPECIFICACIONES TÉCNICAS / TECHNICAL SPECIFICATION / DÉTAILS TECHNIQUES	
Estuche / Case / Étui	1
Mat: PP	●
Compartimentos / Compartments / Cases	8, 16
1 bandeja / 1 tray / 1 plateau	●



■ CANDADOS / PADLOCKS / UN CADENAS / VORHÄNGESCHLOSSE / LUCCHETTI / CADEADOS / ЗАМКИ

COD.	L (mm)	O.D. mm	g
11130	32	5	28
11131	42	5	46



■ BOLSAS PORTAHERRAMIENTAS / TOOL BAGS / SACS PORTE-OUTILS / WERKZEUGTASCHE / BORSA PORTAUTENSILI / BOLSA PORTA FERRAMENTAS / ИНСТРУМЕНТАЛЬНЫЕ СУМКИ

COD.	L x W x H (mm)	Kg-MAX		
51014	495 x 265 x 340	20	50	●



COD.	L x W x H (mm)	Kg-MAX		
51034	400 x 265 x 295	15	32	●



COD.	L x W x H (mm)	Kg-MAX		
51013	400 x 215 x 305	15	22	●



COD.	L x W x H (mm)	Kg-MAX		
51033	400 x 230 x 295	15	16	●



COD.	L x W x H (mm)	Kg-MAX		
50960	415 x 230 x 260	15	15	●



COD.	L x W x H (mm)	Kg-MAX		
50961	495 x 245 x 290	15	36	●



COD.	L x W x H (mm)	Kg-MAX		
50962	510 x 290 x 360	15	4	●



MOCHILA PORTAHERRAMIENTA / TOOL BACKPACK / SAC À DOS PORTE-OUTILS / WERKZEUG RUCKSACK / ZAINO PORTA UTENSILI / MOCHILA PORTA-FERRAMENTA / РЮКЗАК ДЛЯ ИНСТРУМЕНТОВ

COD.	L x W x H (mm)	Kg-MAX		Kg
50963	390 x 220 x 480	20	66	2,1

ESPECIFICACIONES TÉCNICAS / TECHNICAL SPECIFICATION / DÉTAILS TECHNIQUES

Correas acolchadas ajustables / Adjustable padded straps / Bretelles matelassées ajustables	●
Cintas para la fijación de objetos / Strap to tie objects / Sangle pour fixation des objets	●
Bolsillos laterales / Side compartments / Poches latérales	2
Bolsillo interior en la parte delantera / Internal pocket at the front of the pack / Poche intérieure sur la partie avant	1
Bolsillos interiores / Internal pockets / Poches intérieures	63



BOLSA PARA SETS DE LLAVES FIJAS / BAG FOR OPEN-END WRENCH SETS / TROUSSE POUR SET DE CLÉS À FOURCHES / TASCHE F-MAULSCHLÜSSEL / BORSA PER SET DI CHIAVI FISSE / BOLSA PARA CONJUNTO DE CHAVES DE BOCA / СУМКА ДЛЯ НАБОРА РОЖКОВЫХ КЛЮЧЕЙ

COD.	L x W (mm)	PCS.
90052	290 x 250	6
90053	425 x 295	8
90054	510 x 330	10
90055	700 x 370	12

BOLSA PARA SETS DE LLAVES COMBINADAS / BAG FOR COMBINATION WRENCH SETS / TROUSSE POUR SET DE CLÉS MIXTES / TASCHE F-RINGMAULSCHLÜSSEL / BORSA PER SET DI CHIAVI COMBINATE / BOLSA PARA CONJUNTO DE CHAVES COMBINADAS / СУМКА ДЛЯ НАБОРА КОМБИНИРОВАННЫХ КЛЮЧЕЙ

COD.	L x W (mm)	PCS.
90080	245 x 280	6
90081	315 x 300	8
90082	435 x 300	10
90083	505 x 360	12
90060	660 x 490	13
90063	775 x 490	14
90061	710 x 490	15
90064	770 x 440	17
90065	740 x 580	26

BOLSA PARA SETS DE LLAVES ACODADAS / BAG FOR DOUBLE OFFSET RING WRENCH SETS / TROUSSE POUR SET DE CLÉS POLYGONALES / TASCHE F-RINGSCHLÜSSEL / BORSA PER SET DI CHIAVI POLIGONALI / BOLSA PARA CONJUNTO DE CHAVES DE LUNETAS / СУМКА ДЛЯ НАБОРА НАКИДНЫХ КЛЮЧЕЙ

COD.	L x W (mm)	PCS.
90056	325 x 325	6
90057	500 x 370	8
90058	615 x 440	10
90059	755 x 495	12



CHALECO PORTAHERRAMIENTAS / TOOL VEST / VESTE PORTE - OUTILS / WERKZEUGWESTE / GILET PORTAUTENSILI / COLETE PORTA FERRAMENTAS / ЖИЛЕТ ДЛЯ НОШЕНИЯ ИНСТРУМЕНТА

COD.	L x W (mm)
51015	510 x 600



CINTURÓN PORTAHERRAMIENTAS / TOOL BELT / CEINTURE PORTE - OUTILS / WERKZEUGGÜRTEL / CINTURA PORTAUTENSILI / CINTURAO PORTA FERRAMENTAS / ИНСТРУМЕНТАЛЬНЫЙ ПОЯС

COD.	L (inch)	Kg - MAX
51009	32-44	15



ESPECIFICACIONES TÉCNICAS / TECHNICAL SPECIFICATION / DÉTAILS TECHNIQUES

Bolsillos laterales / Side compartments / Poches latérales 21

BOLSA 14 BOLSILLOS / 14 POCKETS NYLON BAG / TROUSSE 14 POCHEs / NYLON TASCHE MIT 14 FÄCHER / BORSA CON 14 TASCHE / BOLSA 14 BOLSOS / НЕЙЛОНОВАЯ СУМКА (14 ОТДЕЛЕНИЙ)

COD.		
50930	14	275

BOLSA 7 BOLSILLOS / 7 POCKETS NYLON BAG / TROUSSE 7 POCHEs / NYLON TASCHE MIT 7 FÄCHER / BORSA CON 7 TASCHE / BOLSA 7 BOLSOS / НЕЙЛОНОВАЯ СУМКА (7 ОТДЕЛЕНИЙ)

COD.		
50931	7	245



BOLSA 6 BOLSILLOS / 6 POCKETS NYLON BAG / TROUSSE 6 POCHEs / NYLON TASCHE MIT 6 FÄCHER / BORSA CON 6 TASCHE / BOLSA 6 BOLSOS / НЕЙЛОНОВАЯ СУМКА (6 ОТДЕЛЕНИЙ)

COD.		
90162	6	115

ACCESORIO PARA MARTILLO / ACESORY FOR HAMMER / ACCESSOIRE POUR MARTEAU / ZUBEHÖR F/HAMMER / ACCESSORIO PER MARTELLO / ACESSÓRIO PARA MARTELO / ПОЯСНОЙ КАРМАН ДЛЯ МОЛОТКА

COD.	
50932	92

CINTO / BELT / CEINTURE / RIEM / CINTURONE / CINTO / ПОЯС

COD.	L (mm)	
50933	135	260

